

**SAMSUNG**

# Instruction Manual

## DVD-AR650

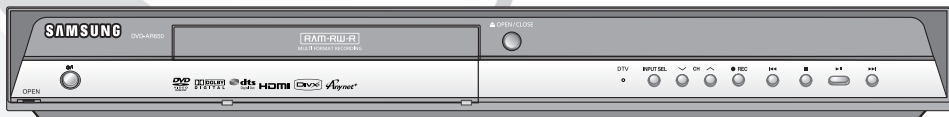

[www.samsung.com](http://www.samsung.com)

AK68-01378A



# Getting Started

## Warning

TO REDUCE THE RISK OF ELECTRIC SHOCK, DO NOT REMOVE THE COVER(OR BACK). NO USER-SERVICEABLE PARTS ARE INSIDE. REFER SERVICING TO QUALIFIED SERVICE PERSONNEL.

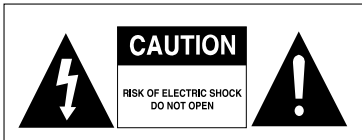

This symbol indicates that dangerous voltage consisting a risk of electric shock is present within this unit.



This symbol indicates that there are important operating and maintenance instructions in the literature accompanying this unit.

Do not install this equipment in a confined space such as a bookcase or similar unit.

**WARNING** : To prevent damage which may result in fire or electric shock hazard, do not expose this appliance to rain or moisture.

**CAUTION** : DVD RECORDERS USE AN INVISIBLE LASER BEAM WHICH CAN CAUSE HAZARDOUS RADIATION EXPOSURE IF DIRECTED. BE SURE TO OPERATE THE RECORDER CORRECTLY AS INSTRUCTED.

### CAUTION

THIS PRODUCT UTILIZES A LASER. USE OF CONTROLS OR ADJUSTMENTS OR PERFORMANCE OF PROCEDURES OTHER THAN THOSE SPECIFIED HEREIN MAY RESULT IN HAZARDOUS RADIATION EXPOSURE. DO NOT OPEN COVERS AND DO NOT REPAIR YOURSELF. REFER SERVICING TO QUALIFIED PERSONNEL.

### CAUTIONS

Caution: To prevent electric shock, match wide blade of plug to wide slot, fully insert.

Attention: Pour éviter les chocs électriques, introduire la lame la plus large de la fiche dans la borne correspondante de la prise et pousser jusqu'au fond.

This product satisfies FCC regulations when shielded cables and connectors are used to connect the unit to other equipment. To prevent electromagnetic interference with electric appliances, such as radios and televisions, use shielded cables and connectors for connections.

FCC NOTE (for U.S.A):

This equipment has been tested and found to comply with the limits for a Class B digital device, pursuant to Part 15 of the FCC Rules. These limits are designed to provide reasonable protection against harmful interference in a residential installation.

This equipment generates, uses and can radiate radio frequency energy and, if not installed and used in accordance with the instructions, may cause harmful interference to radio communications. However, there is no guarantee that interference will not occur in a particular installation.

If this equipment does cause harmful interference to radio or television reception, which can be determined by turning the equipment off and on, the user is encouraged to try to correct the interference by one or more of the following measures:

- Reorient or relocate the receiving antenna.
- Increase the separation between the equipment and receiver.
- Connect the equipment into an outlet on a circuit different from that to which the receiver is connected.
- Consult the dealer or an experienced radio/TV technician for help.

**Caution:** FCC regulations state that any unauthorized changes or modifications to this equipment may void the user's authority to operate it.



- This unit can be used only where the power supply is AC 120V, 60Hz. It cannot be used elsewhere.
- This DVD Recorder is designed and manufactured to respond to the Region Management Information. If the Region number of a DVD disc does not correspond to the Region number of this DVD Recorder, the DVD Recorder cannot play the disc.
- This device is protected by U.S. Patent Nos. 4,631,603; 4,577,216; 4,819,098; 4,907,093; and 6,516,132. This product incorporates copyright protection technology that is protected by U.S. patents and other intellectual property rights. Use of this copyright protection technology must be authorized by Macrovision, and is intended for home and other limited viewing uses only unless otherwise authorized by Macrovision. Reverse engineering or disassembly is prohibited.
- This product is covered by one or more of the following U.S. patents:  
5,060,220 5,457,669 5,561,649 5,705,762 5,987,417  
6,043,912 6,222,983 6,272,096 6,377,524 6,377,531  
6,385,587 6,389,570 6,408,408 6,466,532 6,473,736  
6,477,501 6,480,829 6,556,520 6,556,521 6,556,522  
6,578,163 6,594,208 6,631,110 6,658,588 6,674,697  
6,674,957 6,687,455 6,697,307 6,707,985 6,721,243  
6,721,493 6,728,474 6,741,535 6,744,713 6,744,972  
6,765,853 6,765,853 6,771,890 6,771,891 6,775,465  
6,778,755 6,788,629 6,788,630 6,795,637 6,810,201  
6,862,256 6,868,054 6,894,963 6,937,552

DANGER	- VISIBLE AND INVISIBLE LASER RADIATION WHEN OPEN. AVOID DIRECT EXPOSURE TO BEAM.
CAUTION	- VISIBLE AND INVISIBLE LASER RADIATION WHEN OPEN. AVOID EXPOSURE TO BEAM.
ATTENTION	- RAYONNEMENT LASER VISIBLE ET INVISIBLE EN CAS D'OUVERTURE. EXPOSITION DANGEREUSE AU FAISCEAU.
ADVARSEL	- SYNLIG OG USYNLIG LASERSTRÅLING VED ÅBNING. UNDGÅ UDSÆTTELSE FOR STRÅLING.
VARO!	- AVATTAESSA OLET ALTIHINA NÄKYVÄÄ JA NÄKYMÄTÖN LASERSÄTEILYLLÄ. ÄLÄ KATSO SÄTEESEEN.
VARNING	- SYNLIG OCH OSYNLIG LASERSTRÅLNING NÄR DENNA DEL ÄR ÖPPNAD. BETRAKTA EJ STRÅLEN.
ADVARSEL	- SYNLIG OG USYNLIG LASERSTRÅLING NÄR DEKSEL ÅPNEK. UNNGÅ EKSPONERING FOR STRÅLEN.
VORSICHT	- SICHTBARE UND UNSICHTBARE LASERSTRAHLUNG, WENN ABDECKUNG GEÖFFNET. NICHT DEM STRAHL AUSSETZEN.
注意	- 打开时有可见及不可见激光辐射。避免激光束照射。
注意	- ここを開くと可視及び不可視のレーザー光が出ます。ビームを直接見たり、触れたりしないでください。

## Precaution

### Important Safety Instructions

Read these operating instructions carefully before using the unit. Follow all the safety instructions listed below. Keep these operating instructions handy for future reference.

- 1) Read these instructions.
- 2) Keep these instructions.
- 3) Heed all warnings.
- 4) Follow all instructions.
- 5) Do not use this apparatus near water.
- 6) Clean only with a dry cloth.
- 7) Do not block any ventilation openings, Install in accordance with the manufacturer's instructions.
- 8) Do not install near any heat sources such as radiators, heat registers, stoves, or other apparatus (including amplifiers) that produce heat.
- 9) Do not defeat the safety purpose of the polarized or grounding- type plug. A polarized plug has two blades with one wider than the other. A grounding type plug has two blades and a third grounding prong. The wide blade or the third prong is provided for your safety. If the provided plug does not fit into your outlet, consult an electrician for replacement of the obsolete outlet.
- 10) Protect the power cord from being walked on or pinched particularly at plugs, convenience receptacles, and the point where they exit from the apparatus.
- 11) Only use attachments/accessories specified by the manufacturer.
- 12) Use only with the cart, stand, tripod, bracket, or table specified by the manufacturer, or sold with the apparatus. When a cart is used, use caution when moving the cart/ apparatus combination to avoid injury from tip-over. 
- 13) Unplug this apparatus during lightning storms or when unused for long periods of time.
- 14) Refer all servicing to qualified service personnel. Service is required when the apparatus has been damaged in any way, such as the power-supply cord or plug is damaged, liquid has been spilled or objects have fallen into the apparatus. Service is also required if the apparatus has been exposed to rain or moisture, does not operate normally, or has been dropped.

### Handling Cautions

- Before connecting other components to this recorder, be sure to turn them all off.
- Do not move the recorder while a disc is being played, or the disc may be scratched or broken, and the recorder's internal parts may be damaged.
- Do not put a flower vase filled with water or any small metal objects on the recorder.
- Be careful not to put your hand into the disc tray.
- Do not place anything other than the disc in the disc tray.

- Exterior interference such as lightning and static electricity can affect normal operation of this recorder. If this occurs, turn the recorder off and on again with the POWER button, or disconnect and then reconnect the AC power cord to the AC power outlet. The recorder will operate normally.
- Be sure to remove the disc and turn off the recorder after use.
- Disconnect the AC power cord from the AC outlet when you don't intend to use the recorder for long periods of time.
- Clean the disc by wiping in a straight line from the inside to the outside of the disc.
- Apparatus shall not be exposed to dripping or splashing and no objects filled with liquids, such as vases, shall be placed on the apparatus.
- The Mains plug is used as a disconnect device and shall stay readily operable at any time.

### Maintenance of Cabinet

For safety reasons, be sure to disconnect the AC power cord from the AC outlet.

- Do not use benzene, thinner, or other solvents for cleaning.
- Wipe the cabinet with a soft cloth.

### Disc Handling

- Use discs with regular shapes. If an irregular disc (a disc with a special shape) is used, this DVD Recorder may be damaged.

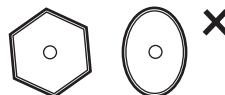

### Holding discs

- Avoid touching the surface of a disc where recording is performed.



### DVD-RAM, DVD-RW and DVD-R

- Clean with an optional DVD-RAM/PD disc cleaner. Do not use cleaners or cloths for CDs to clean DVD-RAM/ DVD-RW/DVD-R discs.



### DVD-Video, Audio CD

- Wipe off dirt or contamination on the disc with a soft cloth.

### Cautions on handling discs

- Do not write on the printed side with a ball-point pen or pencil.
- Do not use record cleaning sprays or antistatic. Also, do not use volatile chemicals, such as benzene or thinner.
- Do not apply labels or stickers to discs. (Do not use discs fixed with exposed tape adhesive or leftover peeled-off stickers.)
- Do not use scratch-proof protectors or covers.
- Do not use discs printed with label printers available on the market.
- Do not load warped or cracked discs.

## Disc Storage

Be careful not to damage the disc because the data on these discs are highly vulnerable to the environment.

- Do not keep under direct sunlight.
- Keep in a cool ventilated area.
- Store vertically.
- Keep in a clean protection jacket.
- If you move your DVD Recorder suddenly from a cold place to a warm place, condensation may generate on the operating parts including the lens and cause abnormal disc playback. When this occurs, do not connect the plug to the power outlet. Wait for two hours, then insert the disc and try to playback again. It will work properly when condensation has evaporated.

## Disc Specifications

### DVD-Video

- A digital versatile disc (DVD) can contain up to 135-minutes of images, 8-language audio and 32 subtitle languages. It is equipped with MPEG-2 picture compression and Dolby 3D surround sound, allowing you to enjoy vivid and clear theater quality images in the comfort of your own home.
- When switching from the first layer to the second layer of a double-layered DVD Video disc, there may be momentary distortion in the image and sound. This is not a malfunction of the unit.
- Once a DVD-R/DVD-RW(V) recorded is finalized, it is playable in a standard DVD player.

### Audio CD

- An audio disc on which 44.1kHz PCM Audio is recorded
- Plays CD-DA format audio CD-R and CD-RW discs. The unit may not be able to play some CD-R or CD-RW discs due to the condition of the recording.

### CD-R/-RW

#### ◆ MP3 CD-R/-RW

- Only CD-R discs with MP3 files recorded with ISO9660 or JOLIET format can be played back
- Only MP3 files with the ".mp3", ".MP3" extension can be used.
- For MP3 files recorded with a VBR(Variable Bit Rates), from 32 Kbps to 320 Kbps, the sound may cut in out.
- Playable bitrate range is from 56Kbps to 320Kbps.
- The unit can handle a maximum of 1000 files and folders.

#### ◆ JPEG CD-R/-RW

- Only JPEG files with the ".jpg", ".JPG" extension can be used.
- The unit can handle a maximum of 1000 files and folders.
- Maximum size of progressive JPEG is 3M pixels.
- MOTION JPEG is not supported.

#### ◆ Using MPEG4 disc

- Disc : CD-R/-RW, DVD-RAM, DVD-R/ DVD-RW,
- MPEG4 File with following extensions can be played. : .avi, .divx, .AVI, .DIVX
- MPEG4 Codec format : DivX 3.11 DivX 4.x DivX 5.x
- Available Audio Format : "MP3", "MPEG", "PCM", "AC3", "DTS"
- Supported subtitle file formats: .smi, .srt, .sub, .psb, .txt

#### ◆ Using CD-R/-RW

- Use a 700MB(80 minutes) CD-R/-RW disc. If possible, do not use a 800MB(90 minutes) or above disc, as the disc may not play back.
- If the CD-R/-RW disc was not recorded as a closed session, you may experience a delay in the early playback time, and all recorded files may not play.
- Some CD-R/-RW discs may not be playable with this unit, depending on the device which was used to burn them.
- When recording from CDs for your personal use to CD-R/-RW discs on your computer, playability may vary depending on the contents and discs.

## DVD-R Disc Playback and Recording

- Once a DVD-R recorded is finalized, it is playable in a standard DVD player. You can record onto the available space on the disc and perform editing functions such as giving titles to discs and programs and erasing programs before finalizing.
- When programming is erased from a DVD-R, that space does not become available. Once an area on a DVD-R is recorded on, that area is no longer available for recording, whether the recording is erased or not.
- It takes about 30 seconds for the unit to complete recording management information after recording finishes.
- This product optimizes the DVD-R for each recording. Optimization occurs when you start recording after inserting the disc or turning on the unit. Recording onto the disc may become impossible if optimization is carried out too many times.
- Playback may be impossible in some cases due to the condition of recording.
- This unit can play back DVD-R discs recorded and finalized with a Samsung DVD video recorder. It may not be able to play some DVD-R discs depending on the disc and the condition of the recording.

## DVD-RW Disc Playback and Recording

- Recording and playback can be performed on DVD-RW discs in both the Video and VR Modes.
- Once a DVD-RW recorded in VR or Video mode is finalized, you cannot perform additional recording.
- Once a DVD-RW is recorded in Video Mode and finalized, it becomes a DVD-Video.
- In both modes, playback can be performed before and after finalization, but additional recording, deleting and editing can not be performed after finalization.
- If you want to record the disc in VR Mode and then record in V Mode, be sure to first reformat the disc. Please be aware that formatting may erase all of the disc's content.

- When inserting an unused disc, a message will appear asking whether to initialize the disc or not. If you select "YES", the disc will be formatted in VR mode.
- **DVD-RW (VR mode)**
  - This is a format that is used for recording data on a DVD-RW disc. You can record multiple titles, edit, delete, partial delete, create a playlist, etc.
  - A disc that is recorded in this mode will not play in standard DVD players.
- **DVD-RW (Video mode)**
  - This is a format that is used for recording data on a DVD-RW or DVD-R disc. The disc can be played by an existing DVD player once it has been finalized.
  - If a disc that has been recorded in Video Mode by a different maker's recorder but has not been finalized, it cannot be played or recorded by this recorder.

### DVD-RAM Disc Playback and Recording

- For cartridge type DVD-RAM discs, remove the cartridge and use only the disc
- Ensure that the recording mode is set to VR. Otherwise, this product will not be able to play the recording.
- You cannot play a DVD-RAM in most DVD players due to compatibility issues.
- Only DVD-RAM standard Version 2.0 discs can be played in this unit.
- DVD-RAM discs recorded on this unit may not work with other DVD Players. To determine compatibility with these DVD-RAM discs, refer to the user's manual for the player.

### COPY PROTECTION

- Many DVD discs are encoded with copy protection. Because of this, you should only connect your DVD Recorder directly to your TV, not to a VCR. Connecting your DVD recorder to a VCR results in a distorted picture from copy-protected DVD discs.
- This product incorporates copyright protection technology that is protected by methods claims of certain U.S. patents and other intellectual property rights owned by Macrovision Corporation and other rights owners. Use of this copyright protection technology must be authorized by Macrovision Corporation, and is intended for home and other limited viewing uses only unless otherwise authorized by Macrovision Corporation. Reverse engineering or disassembly is prohibited.

### Protection

This DVD Recorder can allow you to protect the contents of your discs, as described below.

- Program-protection: See page 69 "Locking a Title"
- Disc-protection: See page 76 "Disc Protection"
- ※ DVD-RAM/DVD-RW/DVD-R discs that are incompatible with the DVD-VIDEO format cannot be played with this product.
- ※ For more information on DVD recording compatibility, consult your DVD-RAM/DVD-RW/DVD-R manufacturer.
- ※ Use of poor quality DVD-RAM/DVD-RW/DVD-R discs may cause the following unexpected problems including, recording failure, loss of recorded or edited materials or damage to the recorder.

### Do not use the following discs!

- LD, CD-G, CD-I, CD-ROM and DVD-ROM discs should not be used in this product.

[Note]

Disc types that can be played :

CD/CD-R/CD-RW/MP3/JPEG/DVD-Video/DVD-RAM/  
DVD-RW/ DVD-R.

DVD+R/+RW cannot record, but finalized +R/+RWs can be played.

A DVD-R/DVD-RW disc which has been recorded in Video Mode on another component can play only when finalized.

- Some commercial discs and DVD discs purchased outside your region may not be playable with this product. When these discs are played, either "No Disc." or "The disc cannot be played. Please check the regional code of the disc." will be displayed.
- If your DVD-RAM/DVD-RW/DVD-R disc is an illegal copy or is not in DVD video format, it may also not be playable.

### ◆ Disc Compatibility

- Not all brands of discs will be compatible with this unit.
- The latest firmware upgrade to improve recording & playback quality can be downloaded from our web site. (Download Center at [www.samsung.com](http://www.samsung.com))
- If disc compatibility problems continue, or there is an issue upgrading your recorder, contact the Call Center at 1-800-SAMSUNG.

# Contents

## Getting Started

■ Warning .....	2
■ Precaution .....	3
Important Safety Instructions .....	3
Handling Cautions .....	3
Maintenance of Cabinet .....	3
Disc Handling .....	3
Disc Storage.....	4
Disc Specifications .....	4
■ General Features .....	8
■ Before Reading the Instruction Manual .....	9
■ How to use the DVD Recorder .....	9
■ Unpacking .....	10
Accessories .....	10
Preparing the Remote Control .....	10
Tour of the Remote Control .....	12
■ Description .....	13
Front Panel.....	13
Front Panel Display.....	13
Rear Panel .....	14

## Connecting & Setting Up

■ Step 1: Connecting the Antenna Cable .....	15
Antenna + DVD Recorder + TV .....	15
Antenna + Cable box or satellite receiver (set top box) + DVD Recorder + TV : Cable box/Satellite receiver with a video/audio output .....	16
Antenna + Cable box or satellite receiver (set top box) + DVD Recorder + TV : Cable box/Satellite receiver with an antenna output only.....	17
■ Step 2 : Connecting HDMI/DVI to a TV .....	18
Connecting to a TV with HDMI Jack .....	18
Connecting to a TV with DVI Jack.....	19
■ Step 3 : Connecting the Video Cable .....	20
Connecting to Component Video Input Jacks (Y,P <sub>B</sub> ,P <sub>R</sub> ).....	20
Connecting to an S-Video Input Jack.....	21
Connecting to a Video Input Jack .....	22
■ Step 4 : Connecting the Audio Cable .....	23
Connecting to your TV .....	23
Connecting to a Stereo Amplifier with Analog Input Jacks .....	24
Connecting to an AV Amplifier with a Digital Input Jack.....	25

■ Step 5 : Connecting External Devices .....	26
Connecting a VCR, Cable box/Satellite receiver (set top box) or DVD Player to the AV 1 IN or S-VIDEO IN Jacks.....	26
Connecting a Camcorder .....	27

## System Setup

■ On-Screen Menu Navigation .....	28
■ Plugging In & Auto Setup .....	28
■ Auto Clock Set.....	29
Time Zone .....	29
Daylight Saving .....	29
■ Manual Clock Set .....	30
■ Auto Channel Memory.....	30
■ Manual Channel Set.....	31
■ Setting Up the System Options .....	32
Set Top Box Control .....	32
CM Skip Time Setting.....	33
EP Mode Time Setting .....	34
Automatic Chapter Creation.....	34
Quick Recording Setting .....	35
Anynet+(HDMI-CEC).....	35
■ Language Setting .....	36
■ Digital Caption .....	37
■ Setting Up the Audio Options .....	38
■ Video(Display) Setting.....	39
TV Aspect.....	39
Input Level.....	39
Black Level.....	40
3D Noise Reduction .....	40
HDMI/DVI Resolution .....	40
DivX(R) Registration .....	40
■ Parental Control .....	41
Setting the Rating Level .....	41
Setting the Digital Rating.....	41
Changing the Password .....	42
■ EPG-Electronic Program Guide .....	42
Viewing Full Guide and Mini Guide .....	43
EPG Timer Recording .....	43

## Recording

■ Recordable discs .....	44
Compatibility between Samsung and Other manufacturer's Recorders .....	44
■ Recording Formats .....	45
DVD-RAM/-RW(VR mode) .....	45
DVD-RW(Video mode)/-R .....	45
■ Recording Mode .....	46
■ Unrecordable Video .....	46
About the INFO Button .....	47
■ Recording immediately .....	48
Recording the current TV program you are watching ..	48
Recording from External Equipment .....	48
■ Copying from a Camcorder .....	49
■ Making a One Touch Recording (OTR) .....	50
■ Setting a Timer Recording .....	51
■ Flexible Recording (for Timer Recording only) .....	52
■ Editing the Scheduled Record List .....	52
■ Deleting the Scheduled Record List .....	53
■ Recording the Scheduled Record List .....	53
■ EZ REC MODE .....	54

## Playback

■ Region code (DVD-Video only) .....	55
■ Logos of Discs that can be played .....	55
■ Disc types that can be played .....	55
Discs That Cannot be Played .....	56
■ Playing a Disc .....	56
Using the Disc Menu & Title Menu .....	57
Using the Playback Related Buttons .....	57
Slow Motion Play .....	58
Step Motion Play .....	58
Using the ANYKEY Button .....	59
■ Playing an Audio CD/MP3 .....	63
Playing an Audio CD(CD-DA) .....	63
Playing an MP3 Disc .....	64
Playing Repeatedly .....	64
■ Playing a Picture CD .....	65
■ Playing an MPEG4 Disc .....	66
■ Playing the Title List .....	67

## Editing

■ Basic Editing (Title List) .....	68
Renaming (Labeling) a Title .....	68
Locking (Protecting) a Title .....	69
Deleting a Title .....	69
Deleting a Section of a Title .....	70
■ Advanced Editing (Playlist) .....	71
Creating a Playlist .....	71
Playing Entries in the Playlist .....	71
Renaming a Playlist Entry .....	72
Editing a Scene for the Playlist .....	72
Copying a Playlist Entry to the Playlist .....	75
Deleting a Playlist Entry from the Playlist .....	75
■ Disc Manager .....	75
Editing the Disc Name .....	75
Disc Protection .....	76
Formatting a Disc .....	76
Finalizing a Disc .....	77
Unfinalizing a Disc (V/VR mode) .....	77
Delete All Title Lists .....	78

## Additional Information

■ Troubleshooting .....	79
■ Cable Box/Satellite Receiver Brand Code Table ....	81
Cable box brand .....	81
Satellite receiver brand .....	83
■ Error Message Solutions .....	84
■ Specifications .....	86
■ Warranty .....	87

## General Features

The DVD-AR650 allows you to record and play high quality digital video on DVD-RAM/DVD-RW/DVD-R discs.

### High quality digital audio and video recording and playback

You can record up to approximately 16-hours of video on a double side 9.4 GB DVD-RAM disc, up to 15-hours on a dual-layer 8.5GB DVD-R disc, and up to 8-hours on a 4.7 GB DVD-RAM/DVD-RW/DVD-R disc, depending on the recording mode.

### Selectable Record Mode

You can set your recorder to one of five different recording speeds, each varying in recording quality and length. EP mode yields the most recording time, LP & SP modes provide less recording time with higher quality recording, and XP mode gives you the highest quality recording. There's also the FR (Flexible Recording) mode that lets you record with the best picture quality possible for the recording time and remaining space on the disc during timer recording.

### Automated Quality Adjustment for Timer Recording

If FR mode is selected, the video quality is adjusted automatically so that all video for the scheduled time can be recorded onto the free disc space. (See pages 51~52)

### Create a DVD video title using a DVD-RW/DVD-R disc

With the DVD-AR650, you can create your own DVD video title on 4.7 GB DVD-RW/DVD-R or 8.5GB DVD-R discs.

### Copying data from a digital camcorder using a DV input jack

Record digital camcorder video onto DVD-RAM, DVD-RW or DVD-R discs using the DV input jack (IEEE 1394-4pin). (See page 49)

### High quality progressive scan

Progressive scanning provides high resolution and flicker free video.

The 10-bit 54-MHz DAC and 2D Y/C Separating Circuitry provides the highest video playback and recording quality. (See page 20)

### A variety of functions with an easy-to-use user interface

The integrated menu system and the messaging function allows you to perform desired operations both easily and conveniently. With a DVD-RAM or DVD-RW (VR mode) disc, you can edit recorded images, create a playlist, and edit videos in a specific sequence according to your requirements.

### MPEG4 playback

This DVD Recorder can play MPEG4 formats within an avi file.

### DivX Certification

DivX, DivX Certified, and associated logos are trademarks of DivXNetworks, Inc and are used under license.



### HDMI (High Definition Multimedia Interface)

HDMI reduces picture noise by allowing a pure digital video/audio signal path from the DVD Recorder to your TV.



### EZ REC MODE













This function allows you to Initialize and Finalize a disc automatically. (See page 54)



## Before Reading the Instruction Manual

Make sure to check the following before reading the user's manual.

### Icons that will be used in manual

Icon	Term	Definition
	DVD	This involves a function available with DVD or DVD-R/DVD-RW (V) discs that have been recorded and finalized.
	RAM	This involves a function available with DVD-RAM discs.
	-RW	This involves a function available with DVD-RW discs.
	-R	This involves a function available with DVD-R discs.
	CD	This involves a function available with a data CD (CD-R or CD-RW).
	JPEG	This involves a function available with JPEG files on CD-R/-RW or DVD-RAM/DVD-RW/DVD-R discs.
	MP3	This involves a function available with MP3 files on CD-R/-RW or DVD-RAM/DVD-RW/DVD-R discs.
	MPEG4	This involves a function available with MPEG4s on CD-R/-RW or DVD-RAM/DVD-RW/DVD-R discs.
	Caution	This involves a case where a function does not operate or settings may be cancelled.
	NOTE	This involves tips or instructions on the page that help each function operate.
	One-Touch button	A function that can be operated by using only one button.
	ANYKEY button	A function that can be operated by using the <b>ANYKEY</b> button.

### About the use of this Instruction Manual

- 1) Be sure to familiarize yourself with the Safety Instructions before using this product. (See pages 2 ~ 5)
- 2) If a problem occurs, check the Troubleshooting section. (See pages 79~80)

### Copyright

©2007 Samsung Electronics Co.  
All rights reserved; No part or whole of this user's manual may be reproduced or copied without the prior written permission of Samsung Electronics Co.

## How to use the DVD Recorder

### Step 1 : Select the disc type

This unit can record on the following types of discs. If you want to repeatedly record on the same disc or you want to edit the disc after recording, select a rewritable DVD-RW or DVD-RAM type disc. If you want to save the recording without making any changes, choose a non-rewritable DVD-R.



### Step 2 : Format the disc to start recording

The recorder automatically starts formatting when an unused disc is inserted. This is required for the preparation of disc recording.

#### Using a DVD-RAM

This type of disc can be formatted with the DVD-Video Recording format (VR mode). You can edit recorded video and create a playlist and edit video in a specific sequence according to your requirements.

#### Using a DVD-RW

- When an unused DVD-RW disc is first inserted, the message "Uninitialized Disc. Do you want to initialize this disc?" will be displayed.

If you select Yes, initializing will begin. A DVD-RW disc can be formatted in either DVD-Video format (Video mode) or DVD-Video Recording format (VR mode)

#### Using a DVD-R

When using a DVD-R disc, only V mode recording is possible and no initialization is needed to play it on this recorder. However, finalization is necessary to play this disc on other DVD players.



- You can only use either the VR or Video mode on a DVD-RW, but not both at the same time.
- You can format a DVD-RW to V or VR mode using disc manager.  
It should be noted that the disc's data will be lost when changing formats.

### Step 3 : Recording

There are two different recording methods. Direct Recording (recording a program you are currently watching) and Timer Recording. Timer recording is determined as a Date : MM/DD, MON-FRI, Every SAT, etc.. There are 5 recording modes : XP(high quality mode), SP(standard quality mode), LP(long recording mode), EP(extended mode) and FR mode. When using FR mode to record, the picture quality is determined by the remaining time on the disc.



- You can make a Timer Recording by using the EPG (Electronic Program Guide). (See page 43)

## Step 4 : Playing

To start playback select the title you want to play from the Title list.

A DVD consists of sections called titles, and sub sections called chapters.

During recording, a title is created between two points where you start and stop recording. Chapters will be created automatically when you finalize recording on DVD-R/DVD-RW discs in Video mode.

## Step 5 : Editing a recorded disc

Editing on discs is easier than editing on conventional video tapes. The recorder supports many different edit functions, possible only with DVDs.

With a simple and easy edit menu, you can operate various edit functions, such as delete, copy, rename, lock, etc., on a recorded title.

With this recorder, you can create playlists using a DVD-RAM/DVD-RW in VR mode. Once a playlist is created you can create/edit a new playlist on the same disc without changing the original recording.

## Step 6 : Finalizing & Playing on other DVD components

To play your DVD on other DVD components, finalizing may be necessary. First, finish all editing and recording operations, then finalize the disc.

### When using a DVD-RW disc in VR Mode

Although finalizing is generally unnecessary when playing the disc on a VR Mode compatible component, a finalized disc should be used for playback.

### When using a DVD-RW disc in Video Mode

The disc should be finalized first to enable playback on anything other than this recorder. No more editing or recording can be made on the disc once it has been finalized.

### When using a DVD-R disc

You should finalize the disc to play it on a component other than this recorder. No more editing or recording can be made on the disc once it has been finalized.



- You can finalize automatically using the EZ REC MODE. (See page 54)

## Unpacking

### Accessories

Check for the supplied accessories below.

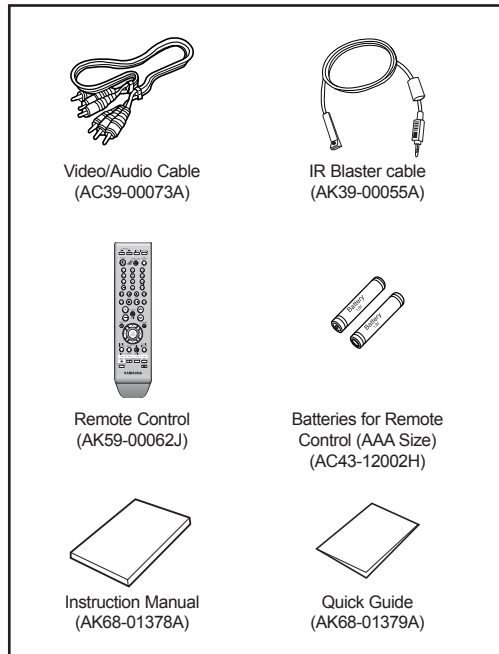

## Preparing the Remote Control

### Install Batteries in the Remote Control

- Open the battery cover on the back of the remote.
- Insert two AAA batteries. Make sure that the polarities (+ and -) are aligned correctly.
- Replace the battery cover.

### If the remote control does not operate properly:

- Check the polarity +/- of the batteries.
- Check if the batteries are drained.
- Check if the remote sensor is blocked by obstacles.
- Check if there is any fluorescent lighting nearby.

Dispose of batteries according to local environmental regulations. Do not put them in the household trash.

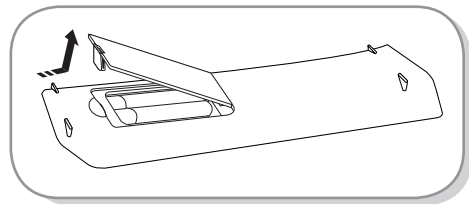

To determine whether your television is compatible, follow the instructions below.

1. Switch your television on.
2. Point the remote control towards the television.
3. Press and hold the **TV POWER** button and enter the two-figure code simultaneously corresponding to the brand of your television by pressing the appropriate number buttons.

Brand	BUTTON
AIWA	82
ANAM	10, 11, 12, 13, 14, 15, 16, 17, 18
BANG & OLUFSEN	57
BLAUPUNKT	71
BRANDT	73
BRIONVEGA	57
CGE	52
CONTINENTAL EDISON	75
DAEWOO	19, 20, 23, 24, 25, 26, 27, 28, 29, 30, 31, 32, 33, 34
EMERSON	64
FERGUSON	73
FINLUX	06, 49, 57
FORMENTI	57
FUJITSU	84
GRADIENTE	70
GRUNDIG	49, 52, 71
HITACHI	60, 72, 73, 75
IMPERIAL	52
JVC	61, 79
LG	06, 19, 20, 21, 22, 78
LOEWE	06, 69
LOEWE OPTA	06, 57
MAGNAVOX	40
METZ	57
MITSUBISHI	06, 48, 62, 65
MIVAR	52, 77
NEC	83
NEWSAN	68
NOBLEX	66
NOKIA	74
NORDMENDE	72, 73, 75
PANASONIC	53, 54, 74, 75
PHILIPS	06, 55, 56, 57
PHONOLA	06, 56, 57
PIONEER	58, 59, 73, 74
RADIOLA	06, 56
RADIOMARELLI	57
RCA	45, 46
REX	74

BRAND	BUTTON
SABA	57, 72, 73, 74, 75
SALORA	74
SAMSUNG	01,02,03,04,05,06,07,08,09
SANYO	41, 42, 43, 44, 48
SCHNEIDER	06
SELECO	74
SHARP	36, 37, 38, 39, 48
SIEMENS	71
SINGER	57
SINUDYNE	57
SONY	35, 48
TELEAVA	73
TELEFUNKEN	67, 73, 75, 76
THOMSON	72, 73, 75
THOMSON ASIA	80, 81
TOSHIBA	47, 48, 49, 50, 51, 52
WEGA	57
YOKO	06
ZENITH	63

Result: If your television is compatible with the remote control, it will switch off.  
It is now programmed to operate with the remote control.



- If several codes are indicated for your television brand, try each one in turn until you find one that works. If you replace the remote control's batteries, you must set the brand code again.

If you select TV mode, you can then control your television using the following buttons.

Button	Function
TV POWER	Used to switch the television on and off.
INPUT SEL.	Used to select an external source.
TV VOL +/-	Used to adjust the volume of the television.
CH (▲ / ▼)	Used to select the desired channel.
TV MUTE	Used to toggle the sound on and off.
0~9	Used to input number directly.



- Various functions may be controllable on your television. If you encounter problems, operate the television directly.

## Tour of the Remote Control

You can control certain functions of another manufacturer's TV with this remote control.

• Buttons that can be controlled on your TV : TV POWER, INPUT SEL., TV VOL (+/-), CH (^/v), TV MUTE, 0~9.

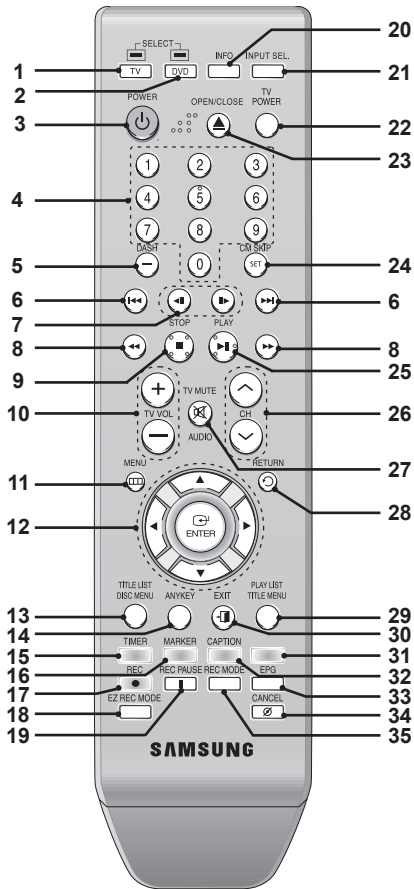

1. **TV Button**  
Press this to operate your TV.
2. **DVD Button**  
Press this to operate your DVD Recorder.
3. **POWER Button**  
Press to power the DVD Recorder on and off.
4. **NUMBER Buttons**
5. **DASH (-) Button**  
Press to select additional channels (digital and analog) being broadcast by the same station. For example, to select channel "54-3", press "54", then press "-" and "3".
6. **REVERSE/FORWARD SKIP Buttons**  
Press to skip a disc backwards or forwards.
7. **REVERSE/FORWARD STEP Buttons**  
Press to play frame by frame.
8. **REVERSE/FORWARD SEARCH Buttons**  
Press to search a disc backwards or forwards.
9. **STOP Button**  
Press to stop a disc or to stop the recording.
10. **TV VOL Buttons**  
Volume adjustment.
11. **MENU Button**  
Brings up the DVD recorder's setup menu.
12. **ENTER/DIRECTION Buttons**  
(UP/DOWN and LEFT/RIGHT Buttons)  
This button functions as a toggle switch.

13. **TITLE LIST/DISC MENU Button**  
Use this to enter the View Recording list/Disc menu.
14. **ANYKEY Button**  
Use this to view the status of the disc that is being played.
15. **TIMER/EPG RED Button**  
Press this to enter the Timer Recording Mode menu. Set the Timer Rec on the EPG.
16. **MARKER/EPG GREEN Button**  
Press this to use Bookmarks or mark a position while playing a disc. Scroll up the detail information on the EPG.
17. **REC Button**  
Use to make a recording on writable/rewritable discs.
18. **EZ REC MODE Button**  
Use this to set the EZ REC MODE.
19. **REC PAUSE Button**  
Press this to pause the recording.
20. **INFO Button**  
This will display current setting or disc status.
21. **INPUT SEL. Button**  
Selects line input signal when an external device is connected. (Analog Ch, Digital Ch, AV1, AV2 or DV)
22. **TV POWER Button**
23. **OPEN/CLOSE Button**  
To open and close the disc tray.
24. **CM SKIP/SET Button**  
Press this to skip a portion of the program automatically during playback of a DVD disc.
25. **PLAY/PAUSE Button**  
Press to play/pause a disc.
26. **CH Buttons**  
Use this to select a channel. (TV/DVD)
27. **TV MUTE/AUDIO Button**  
This operates as Sound Mute. (TV mode)  
Use this to access various audio functions on a disc. (DVD mode)
28. **RETURN Button**  
Returns to the previous menu.
29. **PLAY LIST/TITLE MENU Button**  
Use this to return to the Title menu, or to view the recorded Playlist.
30. **EXIT Button**  
Press this to exit the menu.
31. **EPG BLUE Button**  
Press this to go to Full / Mini Guide on the EPG.
32. **CAPTION/EPG YELLOW Button**  
Press this to select a caption. (DTV mode)  
Also used to scroll down in the EPG.
33. **EPG (Electronic Program Guide) Button**  
Press this to display the EPG. (DTV mode)
34. **CANCEL Button**
35. **REC MODE Button**  
Use this to set the desired Recording time and picture quality. (XP/SP/LP/EP)

\* EPG stands for Electronic Program Guide.

\* This is a special remote control for the visually impaired, and has Braille points on the POWER(Ⓜ), STOP(Ⓜ) and PLAY(Ⓜ) buttons.

## Description

### Front Panel

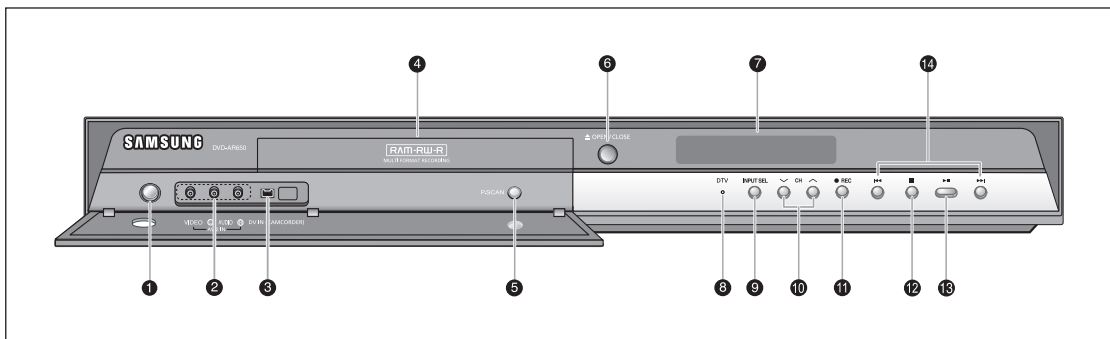

1. **POWER Button**  
Turns the recorder on and off.
2. **AV 2 IN**  
Connect external equipment.
3. **DV-IN**  
Connects external digital equipment with a DV jack. (such as a camcorder)
4. **DISC TRAY**  
Opens to accept a disc.
5. **P.SCAN Button**  
Selects the progressive scan mode.
6. **OPEN/CLOSE Button**  
Opens and closes the disc tray.
7. **DISPLAY**  
Displays the playing status, time, etc.
8. **DTV**  
Lights when a Digital channel is selected.
9. **INPUT SEL. Button**  
Selects line input signal in external mode. (Analog Ch, Digital Ch, AV1, AV2, DV)  
This allows you to select a TV signal or connected external equipment for recording purposes.
10. **CH (^ / v)**  
Select channels.
11. **REC Button**  
Starts recording.
12. **STOP Button**  
Stops disc playback.
13. **PLAY/PAUSE Button**  
Plays a disc or pauses playback.
14. **SKIP Buttons**  
Go to the next title/chapter/track, or go back to the previous title/chapter/track.

### Front Panel Display

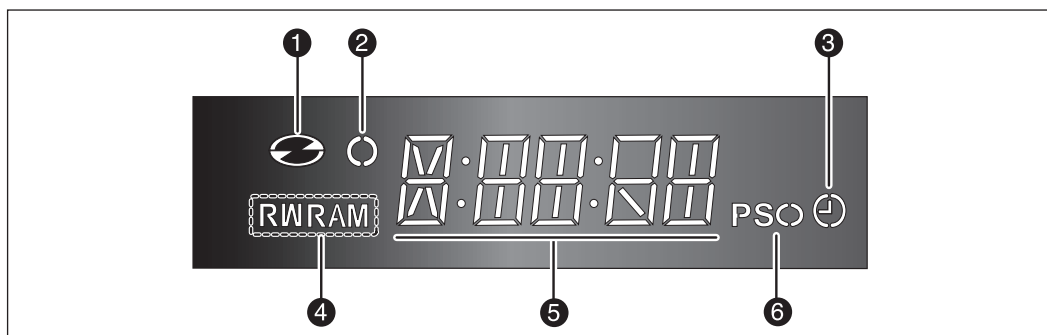

1. Lights when a disc is loaded.
2. Lights in the record mode.
3. Lights to indicate the timer record mode.
4. Lights when a DVD-RAM/DVD-RW/DVD-R disc is loaded.
5. Alpha/Numeric display.
6. Lights in the progressive scan mode.

## Rear Panel

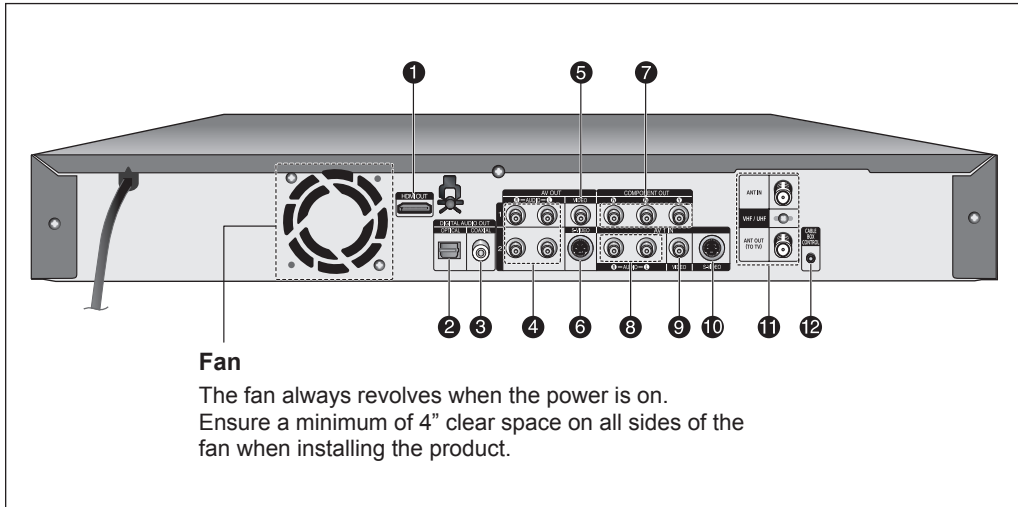

1. **HDMI OUT (best video quality)**  
Connects the input of external equipment using a HDMI cable.
2. **DIGITAL AUDIO OUT(OPTICAL)**  
Connects to an amplifier having a digital optical audio input jack.
3. **DIGITAL AUDIO OUT(COAXIAL)**  
Connects to an amplifier having a digital coaxial audio input jack.
4. **AV AUDIO OUT**  
Connect to the audio input of external equipment using audio cables.
5. **AV VIDEO OUT(good video quality)**  
Connects the input of external equipment using a Video cable.
6. **AV S-VIDEO OUT(better video quality)**  
Connects the input of external equipment using an S-Video cable.
7. **COMPONENT VIDEO OUT (excellent video quality)**  
Connect to equipment having Component video input jacks.
8. **AV 1 AUDIO IN**  
Connect the output of external equipment using audio cables
9. **AV 1 VIDEO IN**  
Connects the output of external equipment using a video cable.
10. **AV 1 S-VIDEO IN**  
Connects the output of external equipment using an S-Video cable.
11. **ANT IN/ANT OUT (TO TV)**  
Connects antenna cables.
12. **CABLE BOX CONTROL OUT**  
Connect the IR Blaster here to control your cable box or satellite receiver (set top box).



# Connecting & Setting Up

## Step 1: Connecting the Antenna Cable

There are several ways to connect your DVD Recorder. Select the antenna connection that best suits you below.

### Antenna + DVD Recorder + TV

You can record non-scrambled channels by selecting the channel on the DVD Recorder. Also use this method if you watch channels without a cable box or satellite receiver (set top box).

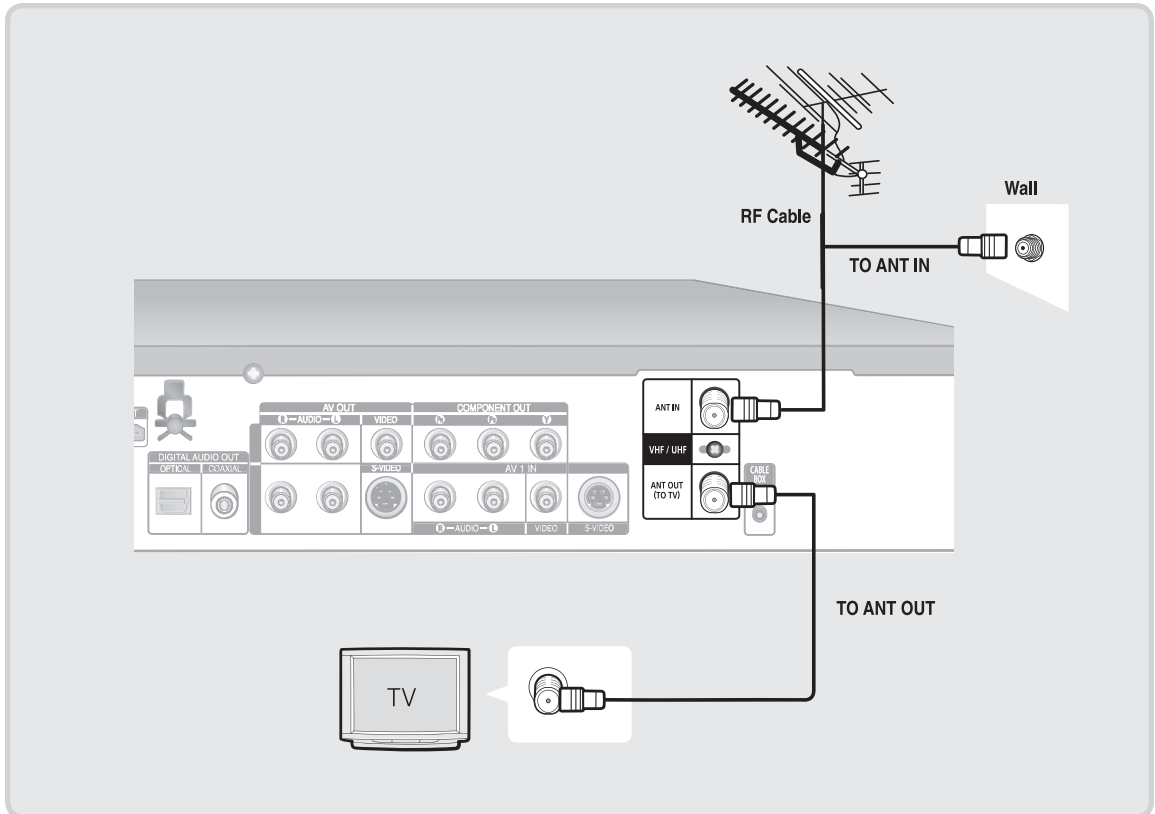

- The VHF/UHF ANT (RF) OUT jack of this product sends only signals received through the antenna. It does not output Audio/Video signals. You must connect Audio/Video cables to view Video from the unit. (i.e. DVD playback)

## Antenna + Cable box or satellite receiver (set top box) + DVD Recorder + TV :

### Cable box/Satellite receiver with a video/audio output

You can record channels by selecting the channel on the cable box or satellite receiver (set top box). You cannot record one channel while watching another channel. Be sure that the cable box or satellite receiver (set top box) is turned on.

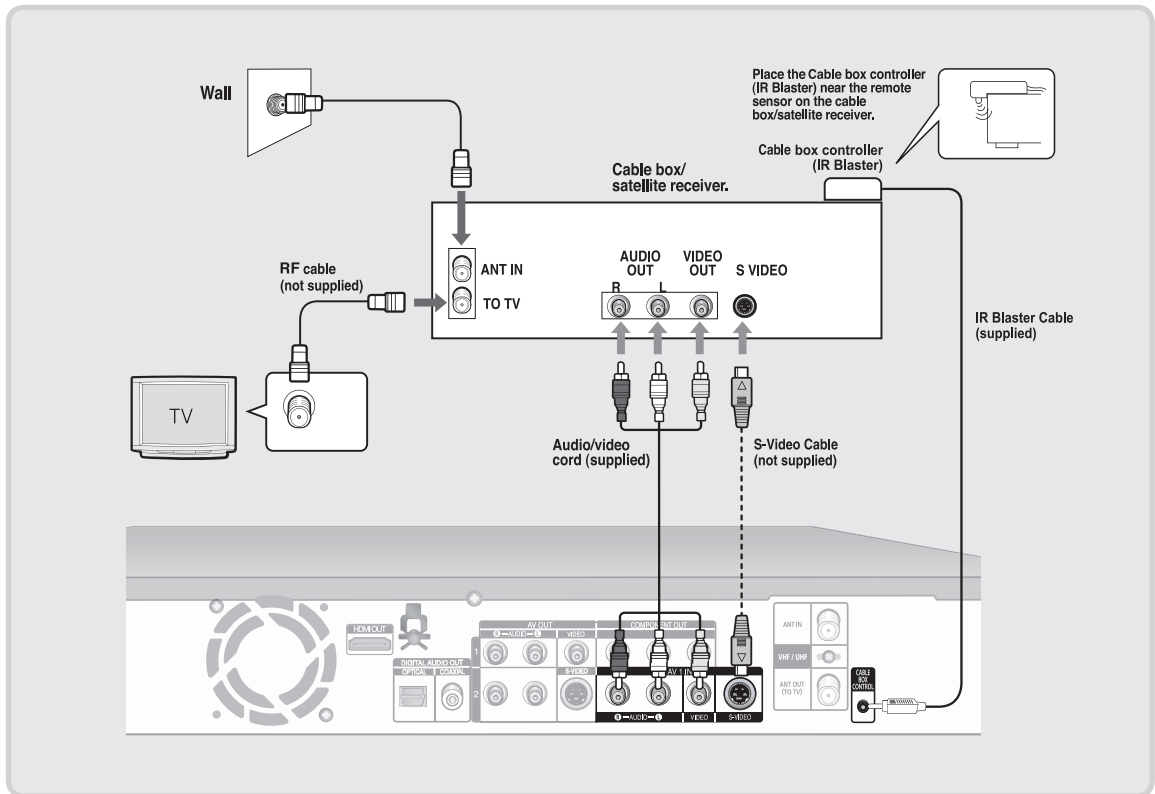

#### Connecting the IR Blaster cable into the Cable Box Control jack

The Cable Box Controller (IR Blaster) is used to control your cable box for recording purposes.

1. Find and Connect the included IR Blaster cable into the Cable Box's Control jack of the DVD Recorder.
2. Find the Cable Box IR Sensor
  - A. Turn the cable box Off.
  - B. Hold the Cable box/Satellite receiver's remote so that it touches the front of the Cable box/Satellite receiver (see Figure 1).

Figure 1

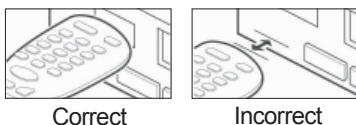

- C. Move the Cable Box's remote across the front of the Cable Box/Satellite Receiver while pressing the remote's power button On and Off (Figure 2).

Figure 2

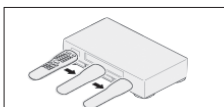

3. Place the IR Blaster.
 

Place the Cable box controller of the IR Blaster on top or underneath the Cable box/Satellite receiver approximately 1 inch in front of the sensor you found in 2. Use the double-sided tape to secure the IR Blaster.

- You must select a Cable box/Satellite receiver brand from the table on pages 81~83. If you do not know the brand name, please contact your cable/satellite provider.
- After setting up your cable box or satellite receiver (Set top box) with the DVD recorder through the IR Blaster cable, you need to set up the Set Top Box Control menu. (See pages 32~33)



## Antenna + Cable box or satellite receiver (set top box) + DVD Recorder + TV : Cable box/Satellite receiver with an antenna output only

*You can record non-scrambled channels by selecting the channel on the DVD Recorder. You cannot record scrambled channels that require a cable box.*

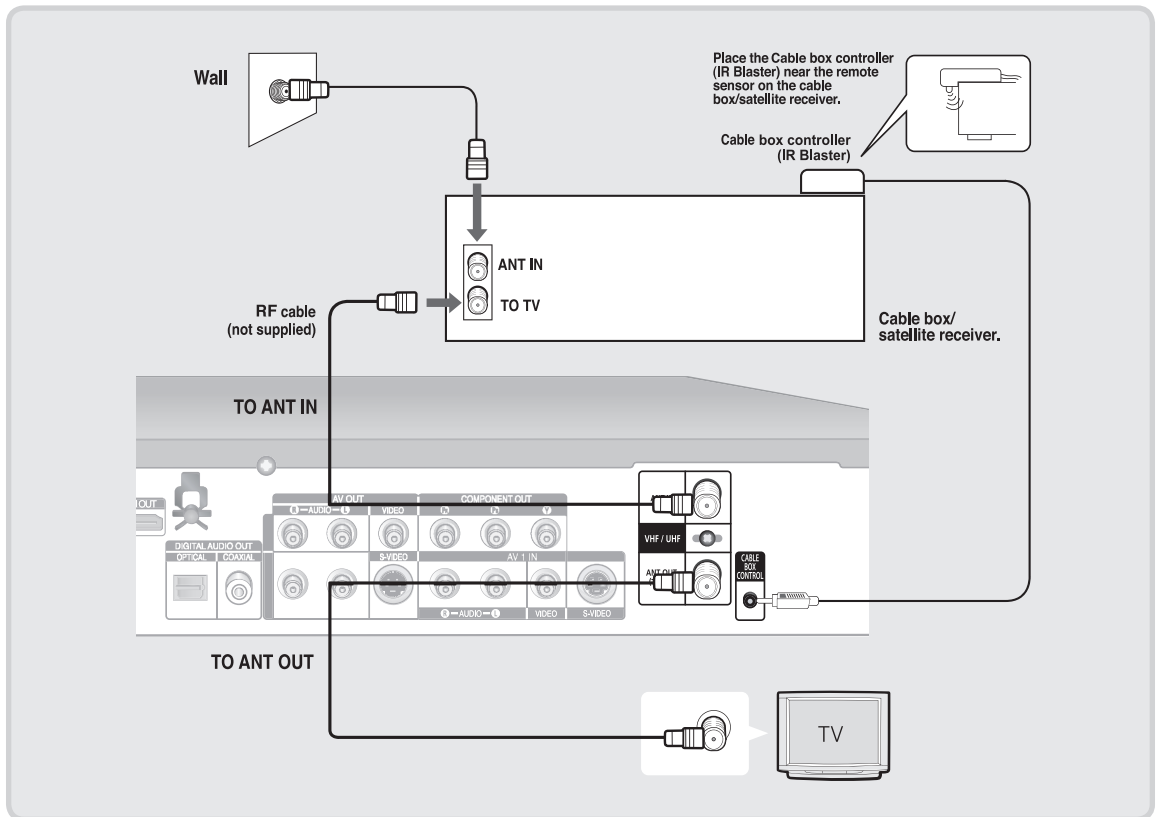

## Step 2 : Connecting HDMI/DVI to a TV

If your TV has an HDMI/DVI input, connect the HDMI/DVI cable to the TV. You will enjoy the best quality image and sound.

### Connecting to a TV with HDMI Jack

Using an HDMI-HDMI cable, connect the HDMI OUT jack on the rear of the DVD Recorder to the HDMI IN jack of your TV. Turn on your TV, then the DVD Recorder. Press the input selector on your TV remote control until the HDMI signal from the DVD Recorder appears on your TV screen.

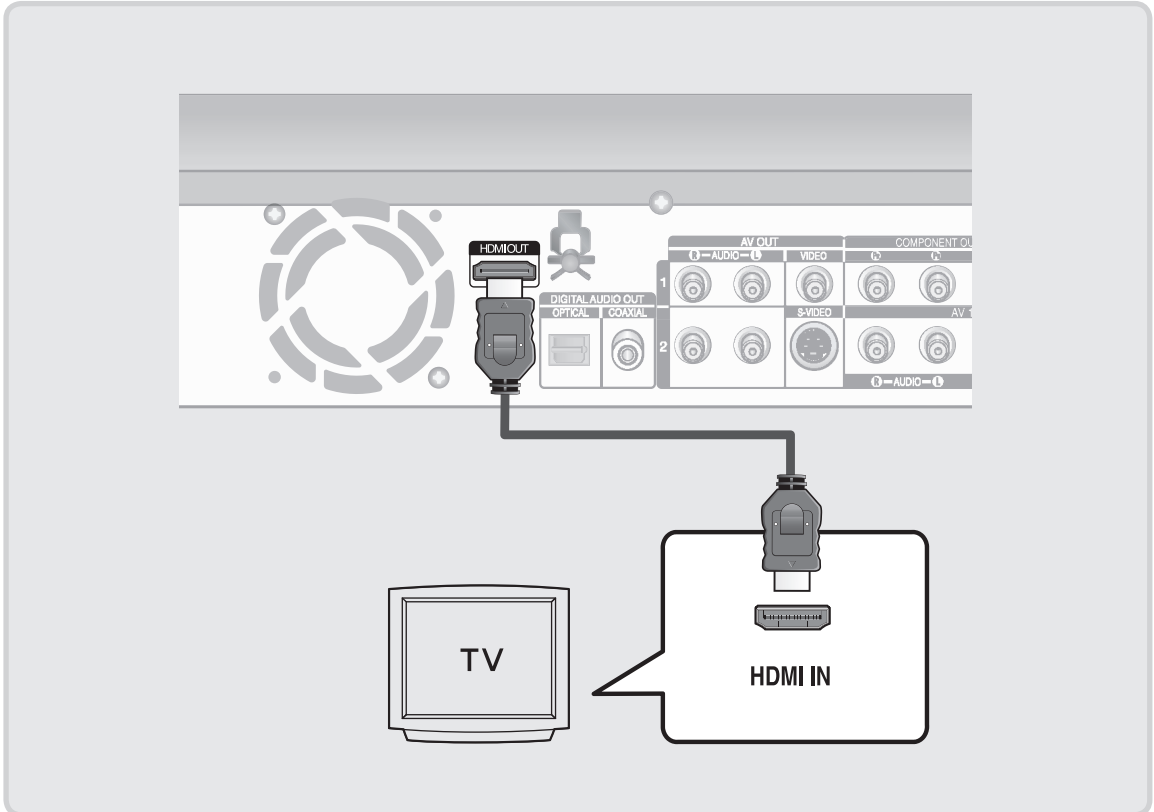

- To watch through the HDMI output, set the digital audio output to PCM. (See page 38)
- Depending on the HDMI device(TV/HDMI Receiver) you use, audio may not be supported. If your TV does not support Dolby digital/DTS, Audio output is not available when you set the Digital output to Bitstream or select DTS On in the Audio setup menu. In this case, set the digital audio output to PCM or DTS Off.
- If you use an HDMI cable to connect a Samsung TV to the DVD recorder, you can operate the recorder using the TV remote control. (This is only available with SAMSUNG TVs that support Anynet+(HDMI-CEC).) (See pages 35~36)
- Please check the *Anynet+* logo (If your TV has an *Anynet+* logo, then it supports Anynet+ function.)

## Connecting to a TV with DVI Jack

Using the HDMI-DVI cable (not included), connect the HDMI OUT terminal on the rear of the DVD Recorder to the DVI IN terminal of your TV.

An HDMI to DVI connection requires a separate audio connection, using the audio cables, connect the AUDIO (red and white) OUT terminals on the rear of the DVD Recorder to the AUDIO (red and white) IN terminals of your TV. Turn on your TV, then the DVD Recorder.

Press the input selector on your TV remote control until the DVI signal from the DVD Recorder appears on your TV screen.

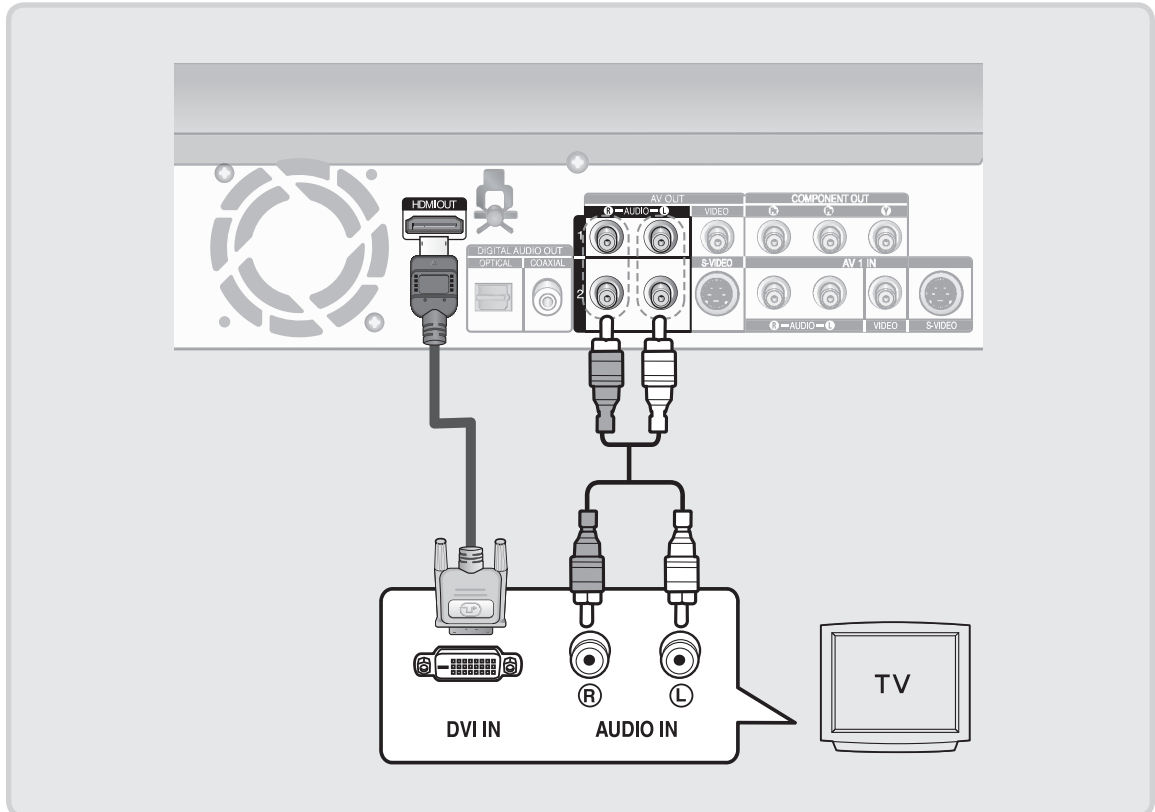

- To set the HDMI output resolution (480p/720p/1080i), see page 40.
- **HDMI (High Definition Multimedia Interface)**  
HDMI enables you to make a digital video and audio connection with a single cable. Using HDMI, the DVD player transmits a digital video and audio signal and displays a vivid picture on a TV having an HDMI input jack.
- HDMI is completely compatible with DVI. The only difference between HDMI and DVI is that HDMI supports multi-channel audio.
- **HDMI connection description**  
HDMI connector - Both uncompressed video data and digital audio data (LPCM or Bit Stream data).
  - The DVD recorder outputs a pure digital signal to the TV.
  - If your TV does not support HDCP (High bandwidth Digital Content Protection), snow noise appears on the screen.

### ■ Why does Samsung use HDMI?

Analog TVs require an analog video/audio signal. However, when playing a DVD, the data transmitted to a TV is digital. Therefore either a digital-to-analog converter (in the DVD Recorder) or an analog-to-digital converter (in the TV) is required. During this conversion, the picture quality is degraded due to noise and signal loss. HDMI technology is superior because it requires no D/A conversion and is a pure digital signal from the DVD recorder to your TV.

### ■ What is the HDCP?

HDCP (High-bandwidth Digital Content Protection) is a system for protecting DVD content output via HDMI from being copied. It provides a secure digital link between a video source (PC, DVD, etc) and a display device (TV, projector, etc). Content is encrypted at the source device to prevent unauthorized copies from being made.

## Step 3 : Connecting the Video Cable

If you have not connected to your TV via HDMI/DVI, select one of the video connections on the following pages.

### Connecting to Component Video Input Jacks (Y,P<sub>B</sub>,P<sub>R</sub>)

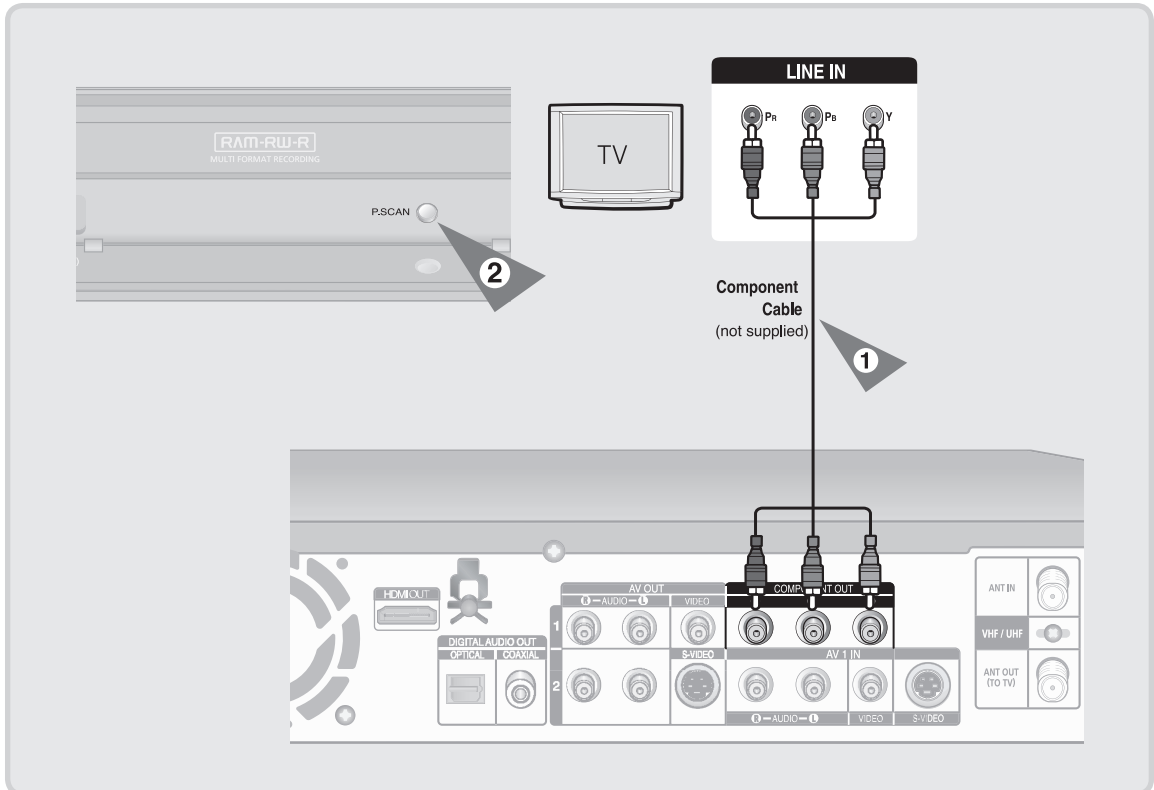

1. Connect the Component video cables(not supplied) between the COMPONENT OUT(Y,P<sub>B</sub>,P<sub>R</sub>) jacks on the DVD Recorder and COMPONENT IN(Y,P<sub>B</sub>,P<sub>R</sub>) jacks on your TV (or AV amplifier). This connection outputs the 480i or 480p resolution to your TV.
  2. If the connected TV supports Progressive Scan, press the P.SCAN button on the front of the DVD Recorder to enjoy best quality video. Pressing the **P.SCAN** button alternately switches the Progressive(480p) or Interlace(480i) scan mode on.
    - You will enjoy the best quality accurate color reproduction images. Component video separates the picture element into black and white(Y), blue(P<sub>B</sub>) and red(P<sub>R</sub>) signals to present clear and clean images.
    - Connect the audio cables(white and red) between the AUDIO OUT jacks on the DVD Recorder and AUDIO IN jacks on your TV(or AV amplifier). (See pages 23~25)
- Compared to standard interlaced video, progressive scan doubles the amount of video lines fed to your TV, resulting in a clearer, more stable, and flicker free image than interlaced video. The component output jack of the DVD player can be used for progressive output mode, which is only available with TVs that support progressive scan.
  - Progressive Scan Output (480p). Not all high definition television sets are fully compatible with this product. If the 480p progressive scan picture is not satisfactory, press the **P.SCAN** button on the unit to switch to the Interlace mode. If there are questions regarding TV set compatibility with this model, please contact our customer service center at 1-800-SAMSUNG.
  - The Component jacks will not output video resolutions above 480p. To view 720p and 1080i, connect the DVD-AR650 to your TV with an HDMI-HDMI cable. With HDMI connected, press the **P.SCAN** button to alternate between all available resolutions. (See page 40)

## Connecting to an S-Video Input Jack

Connect an S-Video cable(not supplied) between the S-VIDEO OUT jack on DVD Recorder and S-VIDEO IN jack on your TV (or AV amplifier).

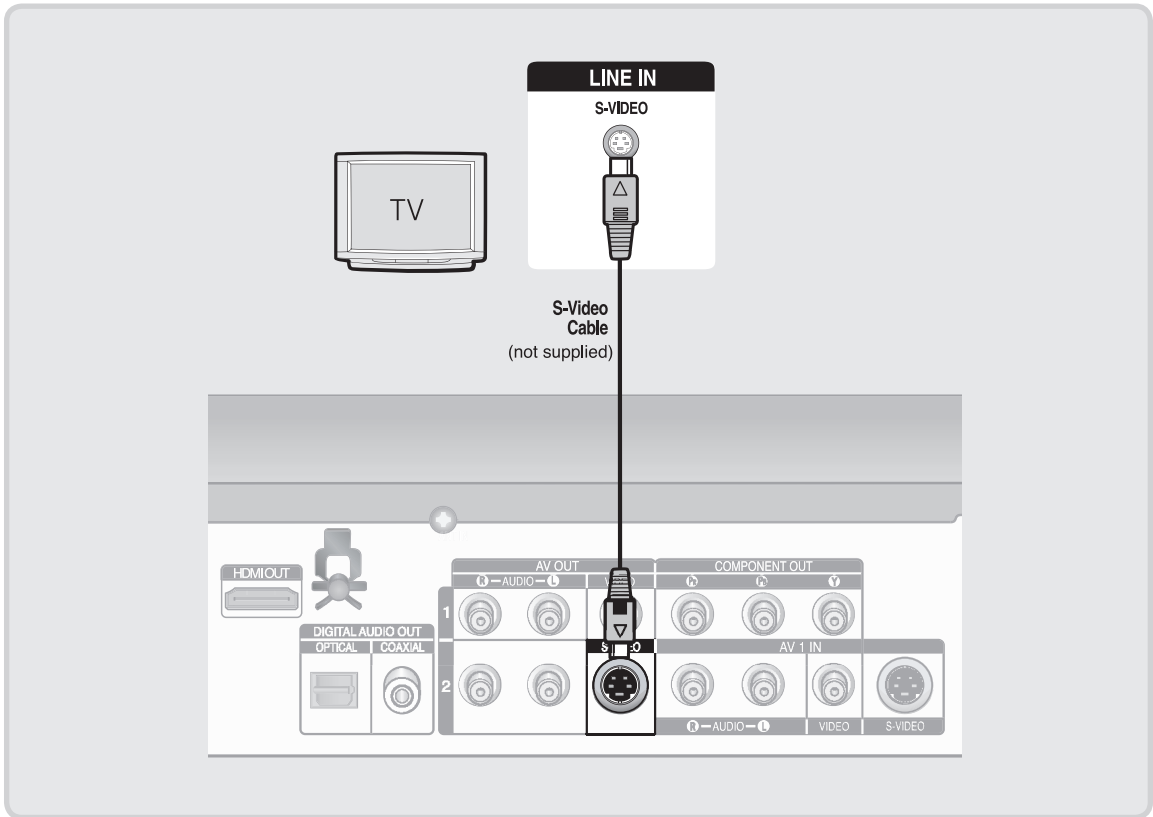

- You will enjoy high quality images. S-Video separates the picture element into black and white (Y) and color (C) signals to present clearer images than regular video input mode. This connection outputs the 480i resolution to your TV.
- Connect the audio cables(white and red) between the AUDIO OUT jacks on the DVD Recorder and AUDIO IN jacks on your TV(or AV amplifier). (See pages 23~25)



- S-Video or Component video outputs are available only if your TV supports S-Video input or Component video input, respectively. If S-Video or Component video output does not work, check your TV connections and the TV input selection settings.

## Connecting to a Video Input Jack

Connect a video(yellow) cable between the VIDEO(yellow) OUT jack on DVD Recorder and VIDEO(yellow) IN jack on the TV (or AV amplifier).

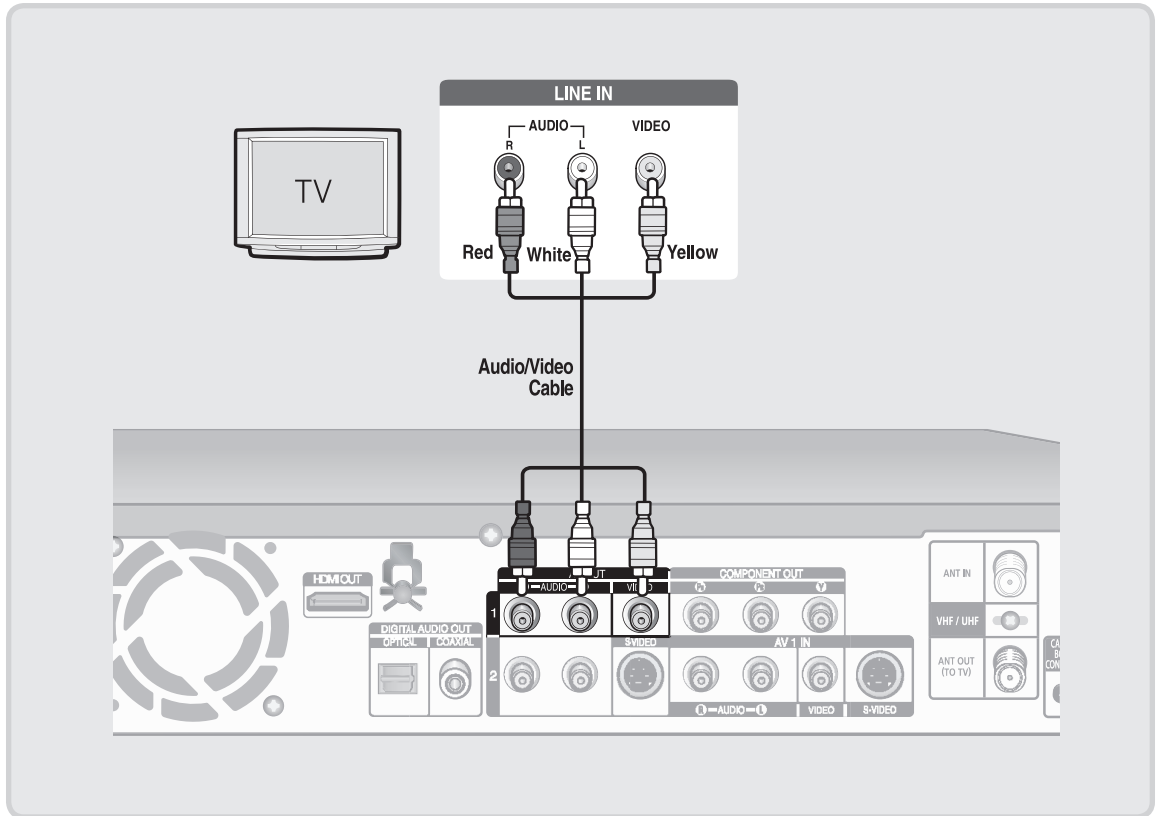

- You will enjoy regular quality images.
- Connect the audio cables(white and red) between the AUDIO OUT jacks on the DVD Recorder and AUDIO IN jacks on your TV(or AV amplifier). (See pages 23~25)

## Step 4 : Connecting the Audio Cable

Select one of the Audio connections on the following pages.

### Connecting to your TV

This connection will use your TV's speakers.

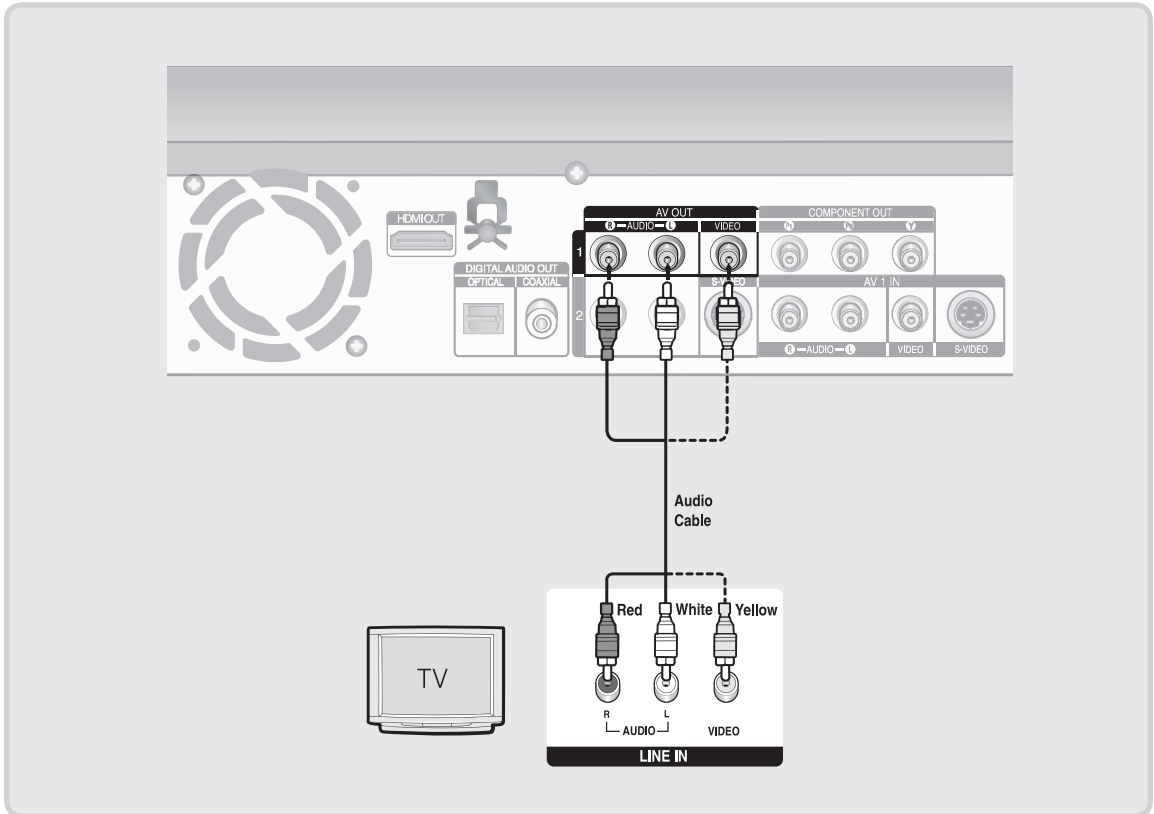

## Connecting to a Stereo Amplifier with Analog Input Jacks

If your stereo amplifier only has **AUDIO INPUT** jacks(L and R), use the **AUDIO OUT** jacks on the recorder.

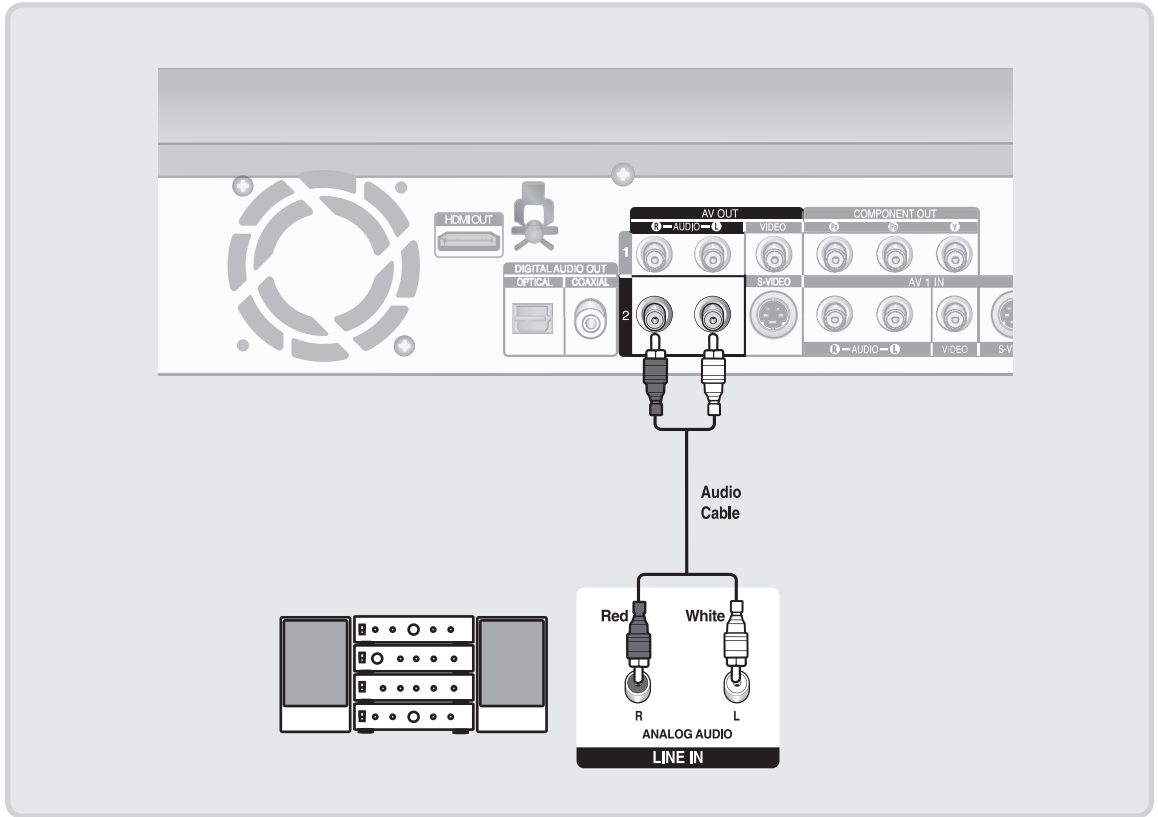



## Connecting to an AV Amplifier with a Digital Input Jack

If your AV amplifier has a Dolby Digital or DTS decoder and a digital input jack, use this connection. To enjoy Dolby Digital or DTS sound, you will need to set up the audio settings. (See page 38)

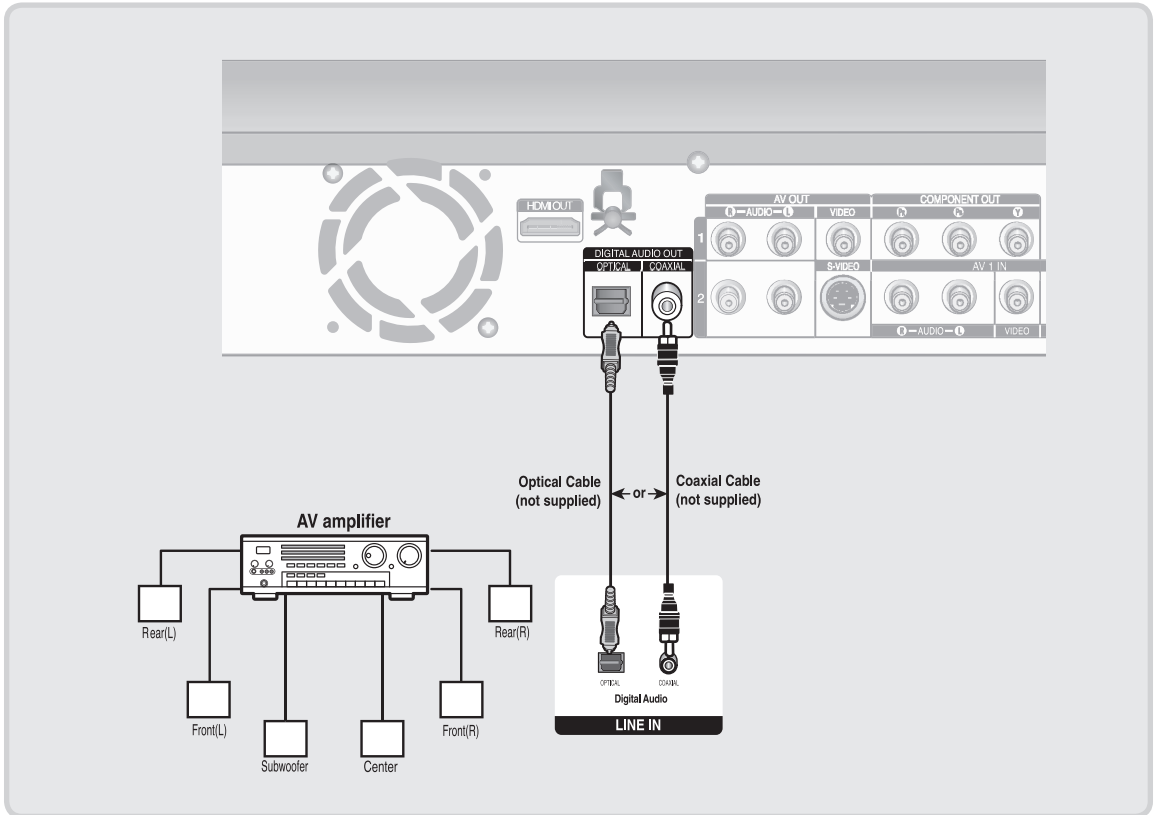

Manufactured under license from Dolby Laboratories. "Dolby" and the double-D symbol are trademarks of Dolby Laboratories.

"DTS" and "DTS Digital Out" are trademarks of DTS, Inc.

## Step 5 : Connecting External Devices

This allows you to connect your DVD Recorder to other external devices and view or record their outputs.

### Connecting a VCR, Cable box/Satellite receiver (set top box) or DVD Player to the AV 1 IN or S-VIDEO IN Jacks

Connecting a VCR or external device to the AV 1 IN jacks of the DVD Recorder.  
 You can record from connected equipment (VCR, STB or DVD Player).

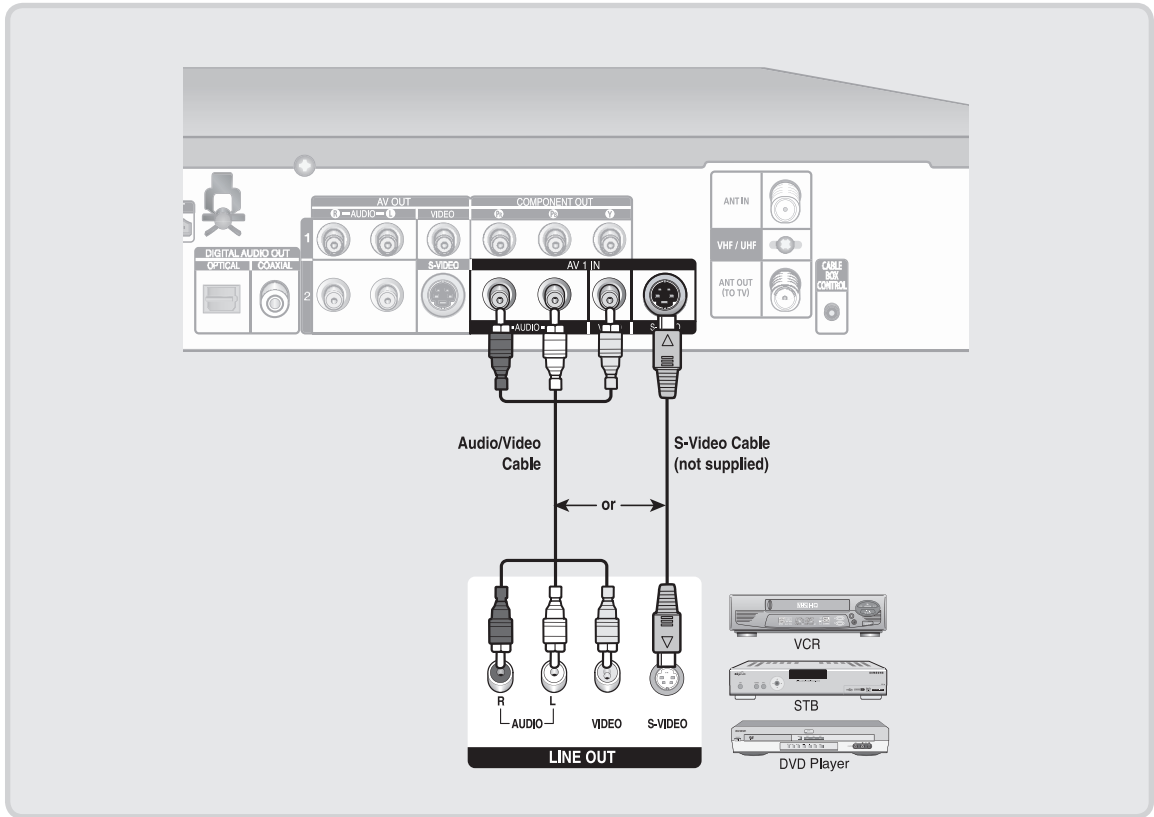

- You must also make audio connections when connecting via S-Video.

## Connecting a Camcorder

You can record from connected equipment, such as a camcorder by using the AV 2 IN or DV IN jacks on front of the DVD Recorder.

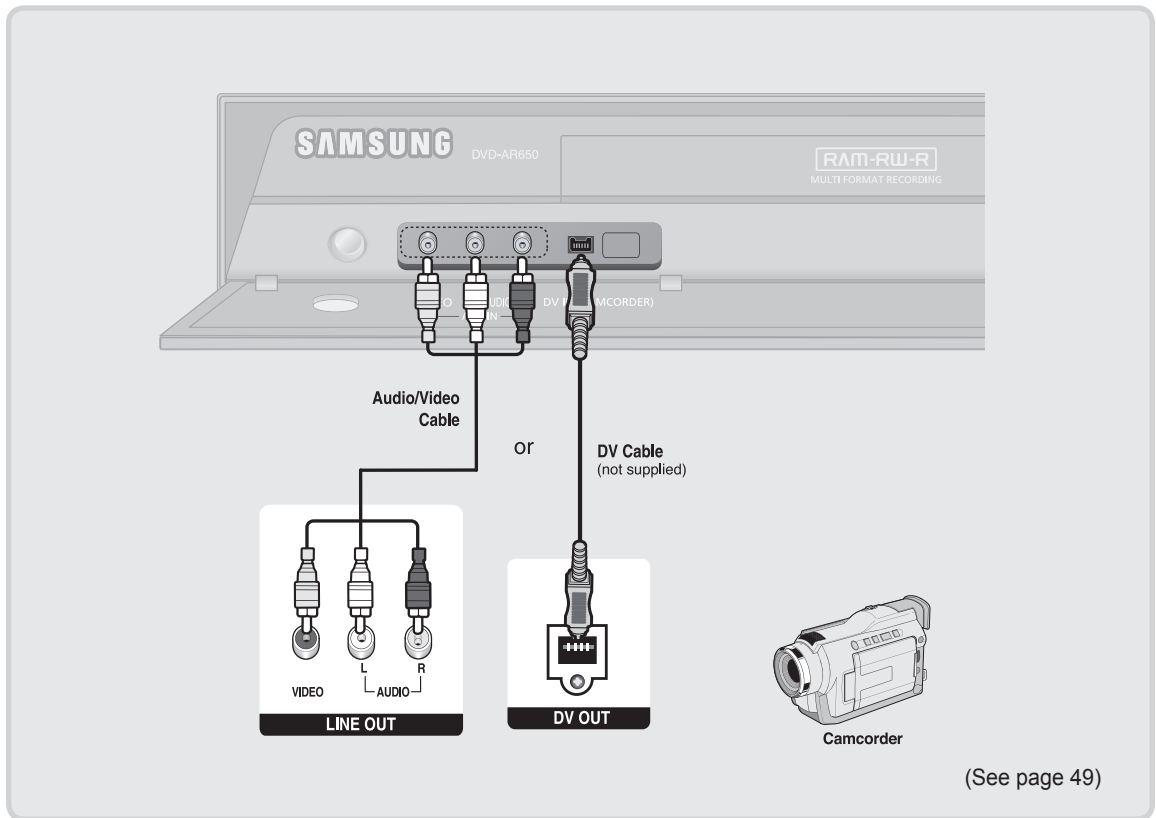

- When an Input source is inserted into AV 2 while watching TV, the Input will be switched to AV 2 automatically.
- If the Input is not selected automatically, press the **INPUT SEL.** button on the remote control to select the DV Input.
- Check your camcorder's owner's manual to see how to use the camcorder in this mode.



# System Setup

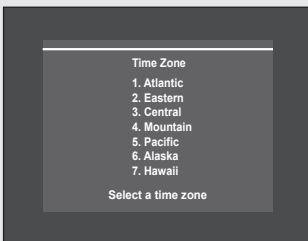
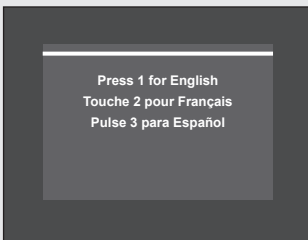

## On-Screen Menu Navigation

The on-screen menus allow you to enable or disable various functions on your DVD Recorder.

Press the MENU button to open the on-screen menu and then use the following buttons to navigate through the on screen menus.

### 1. ▲▼, ◀▶ Buttons

Press these buttons on the remote control to move the selection bar ▲▼, ◀▶ to cycle through the menu options.

### 2. ENTER Button

Press this button on the remote control to confirm any new settings.

### 3. RETURN Button

Press this button on the remote control to return to the Previous menu screen displayed or to exit the on-screen menu.

### 4. EXIT Button

Press this button to exit the on-screen menu.

## Plugging In & Auto Setup

Your DVD Recorder will automatically set itself up when it is plugged in for the first time. TV stations and clock will be stored in memory. The process takes a few minutes. Your DVD Recorder will then be ready for use.

1. Connect the RF(Antenna) cable to the TV as indicated on page 15.
2. Plug the DVD Recorder into the mains.  
"Auto" in the front panel display flickers.
3. Press a **number** button to select the desired language.
4. Press a **number** button to select the desired Time Zone.



- If the language for the startup screen is not set, the settings may change whenever you turn the power on or off. Therefore, make sure that you select the language you want to use.

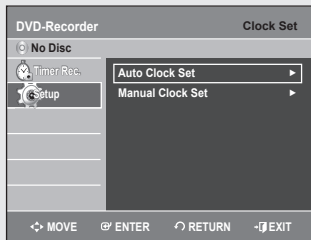

## Auto Clock Set

*This menu is used to set the current time.  
You need to set the time to use timer recording.*

1. With the unit in Stop mode, press the **MENU** button.
2. Press the **▲▼** buttons to select **Setup**, then press the **ENTER** or **▶** button.
3. Press the **▲▼** buttons to select **Clock Set**, then press the **ENTER** or **▶** button.
4. Press the **▲▼** buttons to select **Auto Clock Set**, then press the **ENTER** or **▶** button.



- If your clock is set to the wrong time zone or daylight saving, you can adjust these settings without turning off the Auto Clock Set function.



## Time Zone

- Press the **▲▼** buttons to select **Time Zone**, then press the **ENTER** or **▶** button.  
Select the time zone of your area using the **▲▼** buttons, then press the **ENTER** or **▶** button.

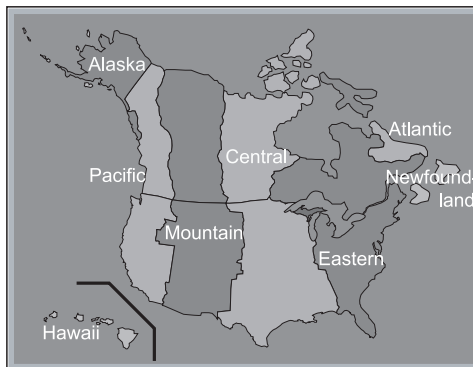

- If Time Zone is not set, Auto Clock Set & Daylight Saving function dose not work.

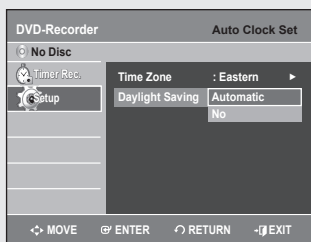

## Daylight Saving

- Press the **▲▼** buttons to select **Daylight Saving**, then press the **ENTER** or **▶** button.  
Select **Automatic** or **No** using the **▲▼** buttons, then press the **ENTER** or **▶** button.

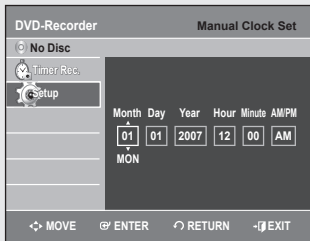

## Manual Clock Set

*If your clock cannot be set automatically, set the clock manually.*

1. With the unit in Stop mode, press the **MENU** button.
2. Press the **▲▼** buttons to select **Setup**, then press the **ENTER** or **▶** button.
3. Press the **▲▼** buttons to select **Clock Set**, then press the **ENTER** or **▶** button.
4. Press the **▲▼** buttons to select **Manual Clock Set**, then press the **ENTER** or **▶** button.
5. Use the **▲▼◀▶** buttons to select the Current Date and Current Time, and then press the **ENTER** button.

When the current time is stored in memory and then the set is powered off, the current time will appear in the front panel display.

- ▲▼ : Sets the value  
You can set the value using the number buttons.
- ◀▶ : Moves to items

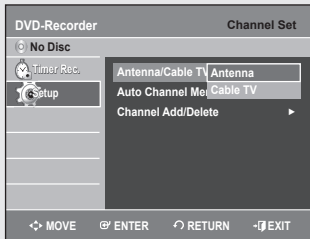

## Auto Channel Memory

*You can set the Antenna/Cable TV channel settings automatically.*

1. With the unit in Stop mode, press the **MENU** button.
2. Press the **▲▼** buttons to select **Setup**, then press the **ENTER** or **▶** button.
3. Press the **▲▼** buttons to select **Channel Set**, then press the **ENTER** or **▶** button.
4. Press the **▲▼** buttons to select **Antenna/Cable TV**, then press the **ENTER** or **▶** button.  
Select the item that matches the antenna connection you selected on pages 15~16.
5. Select **Antenna** or **Cable TV** (depending on the hookup you chose) using the **▲▼** buttons, then press the **ENTER** or **▶** button.
6. Select **Auto Channel Memory** using the **▲▼** buttons, then press the **ENTER** or **▶** button.

Auto Channel Memory (Analog) will be performed, then Auto Channel Memory (Digital) will be performed.

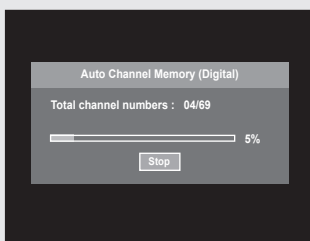
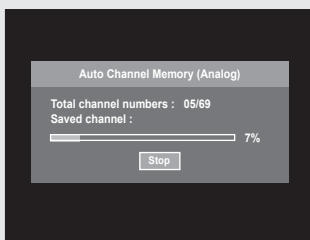

- Press the **RETURN** or **ENTER** button to stop Auto Channel Memory.
- When memorizing Cable channels, it may take 6 times longer (about 50minutes) than when memorizing channels received over the air (antenna).
- Auto Channel Memory (Digital) cannot store scrambled channels.

## Manual Channel Set

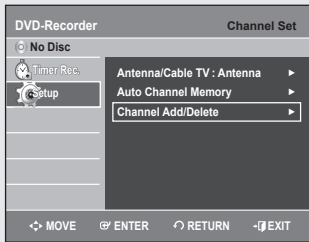

**Manual Channel Set can be used after you have first performed Auto Channel Memory. Use the Manual Channel Setting to delete unnecessary channels.**

1. With the unit in Stop mode, press the **MENU** button.
2. Press the **▲▼** buttons to select **Setup**, then press the **ENTER** or **▶** button.
3. Press the **▲▼** buttons to select **Channel Set**, then press the **ENTER** or **▶** button.
4. Press the **▲▼** buttons to select **Channel Add/Delete**, then press the **ENTER** or **▶** button.
5. Press the **▲▼** or number buttons to select the channels you want to add or delete on the **Select** channel screen. Then, press the **ENTER** button.
  - Using **CH** (☺☹) buttons for channel selection allows the user to add/delete one channel at a time.
  - Using **▲▼** buttons for channel selection jumps to the next channel memorized in Auto Channel Memory.
6. Press the **◀▶** buttons to select **Add** or **Delete**, then press the **ENTER** button.
  - The message “Channel is added.” or “Channel is deleted.” will be displayed in the center of the screen.
  - Continue to add or delete as many channels as you want to memorize or delete. This can be used to add channels not stored automatically due to weak signal strength.
  - Press the **RETURN** button to return to the previous menu. Press the **EXIT** button to exit the menu.

## Setting Up the System Options

### Set Top Box Control

*If you have your cable box/satellite receiver(set top box) connected as shown on page 16, it can be controlled after setting up this menu.*

1. With the unit in Stop mode/No Disc mode, press the **MENU** button on the remote control.  
Menu items differ depending on the disc type.
2. Select **Setup** using the **▲▼** buttons, then press the **ENTER** or **▶** button.
3. Select **System** using the **▲▼** buttons, then press the **ENTER** or **▶** button.  
System menu will be displayed.
4. Select **Set Top Box Control** using the **▲▼** buttons, then press the **ENTER** or **▶** button.  
Set Top Box Control menu will be displayed.
5. Select the desired sub menu(**Control**, **Connection**, **CH Digit Lock**, **Mode for SET button**, and **Brand Code**) using the **▲▼** buttons, then press the **ENTER** or **▶** button.

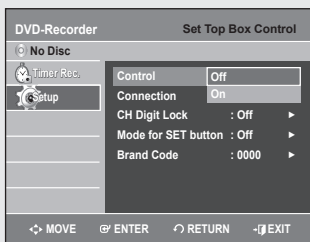
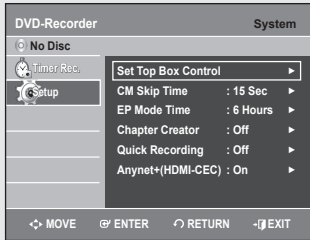

#### Control

Select the sub item(**Off** or **On**) using the **▲▼** buttons, then press the **ENTER** button.

- **Off** : Turns off the cable box or satellite receiver (set top box) control function. Select this if you do not want to use the supplied cable box controller (IR Blaster).
- **On** : Turns on the cable box or satellite receiver (set top box) control function.

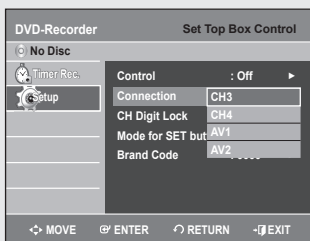

#### Connection

Select the sub item (**AV1**, **S-Video**, **CH3**, **CH4**, **AV2**) using the **▲▼** buttons, then press the **ENTER** button.

If you connect your cable box or satellite receiver (set top box) to the recorder's audio/video input. (page 16)

- **AV1** : Select this when the cable box or satellite receiver (set top box) is connected to the DVD recorder's AV 1 IN jacks.  
You can watch the output of the cable box or satellite receiver (set top box) connected to AV1 when the Recorder is powered off.
- **S-Video** : Select this when the cable box or satellite receiver (set top box) is connected to the DVD recorder's S-Video IN jack.  
You can't select AV1 when the cable box or satellite receiver (set top box) is connected to the S-Video input.
- **AV2** : Select this when the cable box or satellite receiver (set top box) is connected to the DVD recorder's AV 2 IN jacks.

If you connect your cable box or satellite receiver (set top box) to the recorder's antenna input. (page 16)

- **CH3** or **CH4** : Select the output channel from CH3 or CH4 when the cable box or satellite receiver (set top box) is connected to the DVD recorder's VHF/UHF IN jack.

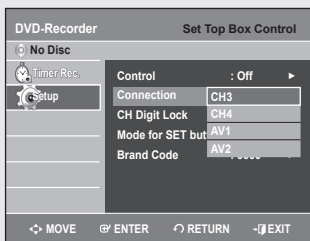

- See the instruction supplied with your cable box or satellite receiver (set top box) to confirm the box's antenna output channel.



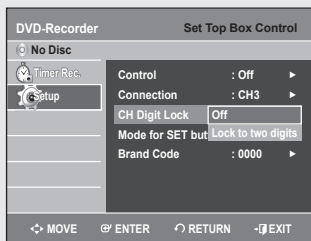

### CH Digit Lock

Select the sub item(**Off** or **Lock to two digits**) using the ▲▼ buttons, then press the **ENTER** button.

- **Off** : Select this when your cable box or satellite receiver (set top box) only accepts a three or more digit channel number. Normally select this.
- **Lock to two digits** : Select this when your cable box or satellite receiver (set top box) only accepts a two digit channel number.

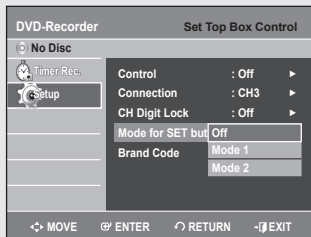

### Mode for SET button

Some cable boxes or satellite receivers (set top box) require you to press SET after pressing the channel number. If your cable box or satellite receiver (set top box) operates this way, follow the instructions below to set Mode 1 or 2.

Select the sub item(**Off**, **Mode 1** or **Mode 2**) using the ▲▼ buttons, then press the **ENTER** button.

Select "Mode 1" or "Mode 2" if your cable box or satellite receiver requires pressing the **SET** button, after entering the channel number.

- **Off** : No code is sent when the **SET** button is pressed. Normally select this.
- **Mode 1** or **Mode 2** : Sends the channel number you entered.



- If "Mode 1" does not work, try "Mode 2."
- If your cable box or satellite receiver (set top box) does not respond to either setting, contact the manufacturer.

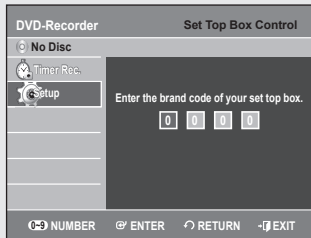

### Brand Code

Enter the brand code of your cable box or satellite receiver (set top box) using the number buttons, then press the **ENTER** button.

(See "Cable Box/Satellite Receiver Brand Code Table" on pages 81~83.)



- If you cannot get the recorder to control your cable box/satellite receiver (set top box), check the connection and position of the IR Blaster cable. (page 16)  
If your cable box or satellite receiver still does not operate with this recorder, contact your cable company to see if they can provide you with a compatible cable box or satellite receiver.
- This menu may not work depending on your cable box or satellite receiver (set top box).

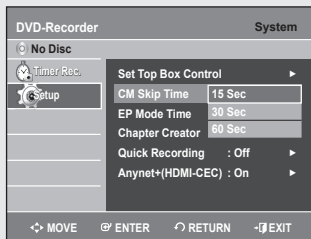

### CM Skip Time Setting

**When a program recorded on a DVD-RAM, a DVD-RW, DVD-VIDEO or a DVD-R is played, the unit can be set to automatically skip a portion of the program corresponding to a CM(commercial) Skip Time set by the user.**

1. With a disc inserted and the unit in Stop mode, press the **MENU** button on the remote control.
2. Select **Setup** using the ▲▼ buttons, then press the **ENTER** or ► button.
3. Select **System** using the ▲▼ buttons, then press the **ENTER** or ► button.  
System menu will be displayed.
4. Select **CM Skip Time** using the ▲▼ buttons, then press the **ENTER** or ► button.  
CM Skip Time will be displayed.
5. Select the desired time using the ▲▼ buttons, then press the **ENTER** or ► button.
6. If you press the **CM SKIP** button during playback, the section corresponding to the set time is skipped, and then the next section is played.



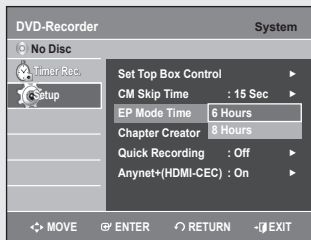

- CM Skip can be performed only during normal playback.
- When the time set is less than the remaining time of a current title: The next title is played from the beginning.
- When the time set is less than the remaining time of a playlist, the next scene is played.
- CM Skip does not work in a still picture mode.
- When a set time is less than the remaining time of a scene, last title, or last track that is currently displayed, a prohibition mark appears.
- CM Skip releases Repeat (including Repeat A-B, Chapter, and Title).
- CM Skip may not operate with some DVD-Video discs.

## EP Mode Time Setting

*You can set the EP (Extended Play) record mode's time to 6 or 8 hours.*

1. With a disc inserted and the unit in Stop mode, press the **MENU** button on the remote control.
2. Select **Setup** using the **▲ ▼** buttons, then press the **ENTER** or **▶** button.
3. Select **System** using the **▲ ▼** buttons, then press the **ENTER** or **▶** button.
4. Select **EP Mode Time** using the **▲ ▼** buttons, then press the **ENTER** or **▶** button.  
EP Mode Time will be displayed.
5. Select the desired menu using the **▲ ▼** buttons, then press the **ENTER** or **▶** button.

## Automatic Chapter Creation

*This function creates chapters(sections) within a title automatically. It works with DVD-RW (Video) and DVD-R discs only.*

1. With a disc inserted and the unit in Stop mode, press the **MENU** button on the remote control.
2. Select **Setup** using the **▲ ▼** buttons, then press the **ENTER** or **▶** button.  
You can't use the Setup functions while playing a disc.
3. Select **System** using the **▲ ▼** buttons, then press the **ENTER** or **▶** button.  
System menu will be displayed.
4. Select **Chapter Creator** using the **▲ ▼** buttons, then press the **ENTER** or **▶** button.  
Chapter Creator items will be displayed.
5. Select **On** using the **▲ ▼** buttons, then press the **ENTER** button.
  - **Off** : Select this option when you do not want to create chapters.
  - **On** : Select this option when you want to create chapters.



- Set the chapter creator to on and then start recording. Stopping the recording will automatically create a chapter menu.
- This function only works for normal recording.
  - After the recording has begun, the "Do you want to create the chapter menu after this recording?" message appears for 10 seconds. Select **Yes** or **No**.
  - Selecting **Yes** will create a new chapter menu while selecting **No** will not.
  - A new chapter is created according to the selected recording mode. A chapter will be about 5 minutes long in XP and SP, and about 15 minutes long in LP and EP mode.
- To display the created chapters and finalize the disc, press the **DISC MENU** button. The chapters menu appears.



- The Automatic Chapter Creation function does not work during Timer Recording or when you turn the power off.

## Quick Recording Setting

*It takes about 10 seconds for a disc to load (initialize) every time you turn on the unit. To bypass this initialization process, you can set the Quick Recording feature to On. This enables you to record immediately without having to wait for the disc to load.*

1. With a disc inserted and the unit in Stop mode, press the **MENU** button on the remote control.
2. Select **Setup** using the **▲▼** buttons, then press the **ENTER** or **▶** button.
3. Select **System** using the **▲▼** buttons, then press the **ENTER** or **▶** button.  
System menu will be displayed.
4. Select **Quick Recording** using the **▲▼** buttons, then press the **ENTER** or **▶** button.  
Quick Recording menu will be displayed.
5. Select **On** using the **▲▼** buttons, then press the **ENTER** or **▶** button.



- The Quick Recording is set to Off as default.
- If the Quick Start Recording is set to On, the fan may continue to operate after the unit is shut off.

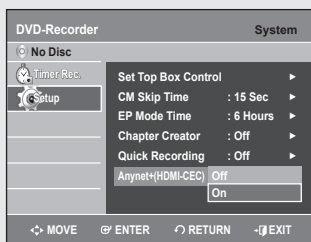

## Anynet+(HDMI-CEC)

*Anynet+ is a function that can be used to operate the recorder using a Samsung TV remote control, by connecting the DVD Recorder to a SAMSUNG TV using an HDMI Cable. (see page 18) (This is only available with SAMSUNG TVs that support Anynet+.)*

1. With the unit in Stop mode/No Disc mode, press the **MENU** button on the remote control.
2. Select **Setup** using the **▲▼** buttons, then press the **ENTER** or **▶** button.
3. Select **System** using the **▲▼** buttons, then press the **ENTER** or **▶** button.  
The system menu will be displayed.
4. Select **Anynet+(HDMI-CEC)** using the **▲▼** buttons, then press the **ENTER** or **▶** button.  
Anynet+(HDMI-CEC) items will be displayed.
5. Select **On** using the **▲▼** buttons, then press the **ENTER** or **▶** button.



## Digital Caption

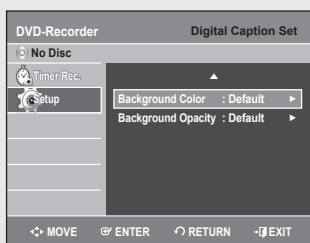
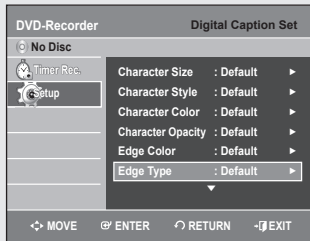
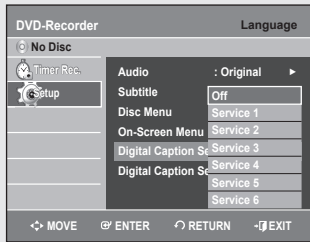

You can modify and configure how your captions will appear. The Digital Captioning function operates on digital channels only.

1. With the unit in Stop mode/No Disc mode, press the **MENU** button on the remote control.
2. Select **Setup** using the **▲▼** buttons, then press the **ENTER** or **▶** button.
3. Select **Language** using the **▲▼** buttons, then press the **ENTER** or **▶** button. The language setup menu will be displayed.
4. Select **Digital Caption Service** using the **▲▼** buttons, then press the **ENTER** or **▶** button.

You can set the service type according to your environment. The available types are Service 1~6.

You can also change Digital Caption Service by pressing Caption button on the remote control.

5. Select **Digital Caption Setting** using the **▲▼** buttons, then press the **ENTER** or **▶** button.

You can set the following options:

- **Character Size** : You can set your Character size to Default, Small, Standard and Large.
- **Character Style** : You can set your Character style among Default and styles 0 through 7.
- **Character Color** : You can set the Character color of the text. The available options are Default, White, Black, Red, Green, Blue, Yellow and Magenta.
- **Character Opacity** : You can set the opacity of the text. The available options are Default, Solid, Translucent and Transparent.
- **Edge Color** : You can set the Edge color of the text. The available options are Default, White, Black, Red, Green, Blue, Yellow and Magenta.
- **Edge Type** : You can set the Edge type of the text. The available options are Non, Raised, Depressed, Outline, Left Shadow and Right Shadow.
- **Background Color** : You can set the Background color of the text. The available options are Default, White, Black, Red, Green, Blue, Yellow and Magenta.
- **Background Opacity** : You can set the Background opacity of the text. The available options are Default, Solid, Translucent and Transparent.

## Setting Up the Audio Options

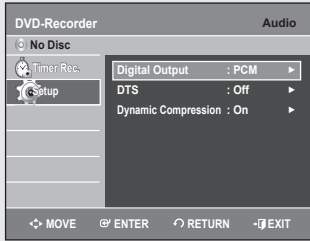

You can connect the DVD-AR650 to an external audio amplifier or a Home Theater system.

This allows you to setup the audio device and sound status settings depending on the audio system in use.

1. With the unit in Stop mode/No Disc mode, press the **MENU** button on the remote control.
2. Select **Setup** using the **▲▼** buttons, then press the **ENTER** or **▶** button.
3. Select **Audio** using the **▲▼** buttons, then press the **ENTER** or **▶** button.
4. Select the sub menu (**Digital Output**, **DTS**, **Dynamic Compression**) using the **▲▼** buttons, then press the **ENTER** or **▶** button.

Select the item that matches the audio connection you've selected on pages 23~35 (Method 1, 2 and 3).

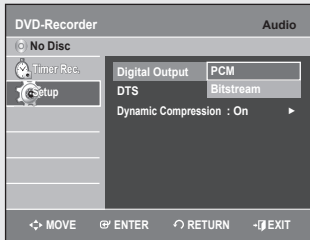

### Digital Output

- **PCM** : Converts to PCM(2CH) 48kHz audio.  
Select PCM if your amplifier system is stereo and/or Dolby Prologic.
- **Bitstream** : Outputs Bitstream.  
Select Bitstream if your amplifier system supports multi channel digital audio surround decoding such as Dolby Digital and/or DTS.

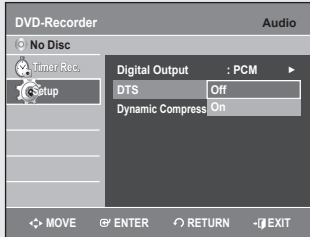

### DTS

- **Off** : Doesn't output DTS bitstream.
- **On** : Outputs DTS bitstream. (via Digital Audio Output)  
Select DTS when connecting to a digital amp with a DTS decoder.
- When DTS soundtrack is played, sound is not output from Analog Audio Output.

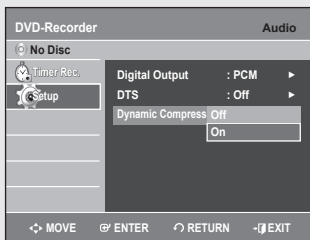

### Dynamic Compression

*This is only active when a Dolby Digital signal is detected.*

- **Off** : You can enjoy the movie with the standard Dynamic Range.
- **On** : When movie soundtracks are played at low volume or from small speakers, the system can apply appropriate compression to make low-level content more intelligible and prevent dramatic passages from getting too loud.

## Video(Display) Setting

This allows you to set up the TV screen size settings.

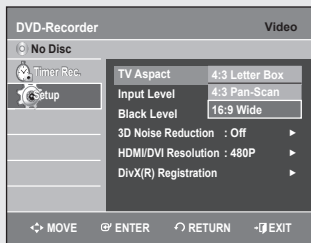

### TV Aspect

1. With the unit in Stop mode/No Disc mode, press the **MENU** button.
2. Select **Setup** using the **▲▼** buttons, then press the **ENTER** or **▶** button.
3. Select **Video** using the **▲▼** buttons, then press the **ENTER** or **▶** button.
4. Select **TV Aspect** using the **▲▼** buttons, then press the **ENTER** or **▶** button.
5. Select the desired item (**4:3 Letter Box**, **4:3 Pan-Scan** or **16:9 Wide**) using the **▲▼** buttons.  
Then press the **ENTER** or **▶** button.

#### If you have a 4:3 standard TV

- **4:3 Letter Box** : Select when you want to see the total 16:9 ratio screen DVD supplies, even though you have a TV with a 4:3 ratio screen. Black bars will appear at the top and bottom of the screen.
- **4:3 Pan-Scan** : Select this for a conventional size TV when you want to see the central portion of the 16:9 screen. (Extreme left and right side of movie picture will be cut off.)

#### If you have a wide screen TV or 4:3 standard TV with a wide-screen mode

- **16:9 Wide** : You can view the full 16:9 picture on your widescreen TV.

#### When receiving a digital broadcast

Setting Value	Source	16:9
16:9 (default)	16:9	
	4:3	
4:3 (letter box or Pan& Scan)	16:9	
	4:3	

- If you set the 4:3 ratio, the screen format will change automatically depending on the broadcast signal.
- If you set a different ratio from the one actually being broadcast, the picture may be distorted (stretched or narrow).

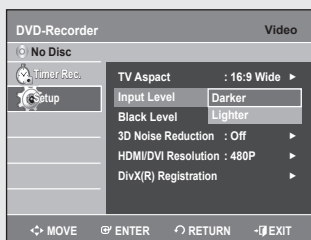

### Input Level

Adjusts the level of the input signal.

- **Darker** : If you feel the screen is too light and you want to make the screen darker.
- **Lighter** : If you feel the screen is too dark and you want to make the screen lighter.

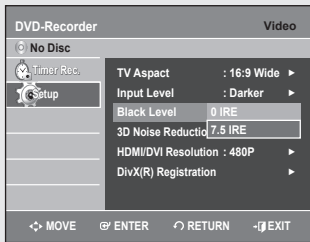

## Black Level

Adjusts the black level of the screen.

- **0 IRE** : Select this when you want a darker screen.
- **7.5 IRE** : Select this when you want a lighter screen.



- The Black level function is not available in the progressive scan mode.
- IRE: Short for the Institute of Radio Engineers. An IRE unit is a relative unit of measure equaling 1/140th of the peak-to-peak (p-p) video amplitude.

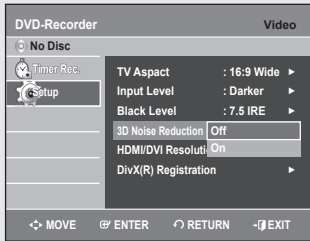

## 3D Noise Reduction

- **Off** : Normal
- **On** : Provides a cleaner picture through noise reduction (for recording).

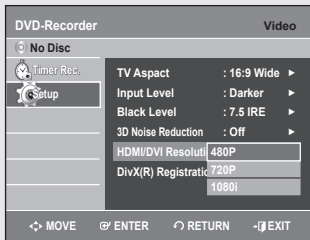

## HDMI/DVI Resolution

*This setting is used when the unit is connected by HDMI or DVI to Display devices (TV, projector, etc).*

- **480p** : 720 x 480
- **720p** : 1280 x 720
- **1080i** : 1920 x 1080
- Connect the DVD-AR650 to your TV via HDMI or DVI. Set your TV's input to HDMI or DVI.
- Press the **P.SCAN** button while the unit is in stop mode to select the output resolution.
  - If your TV is connected via an HDMI or DVI cable, the output resolution mode changes in the following sequence each time you press the **P.SCAN** button:  
 ↳ 480p → 720p → 1080i. ↳
  - If the DVD Recorder is connected to your TV with Component cables (no HDMI/DVI cable connected), the output resolution mode toggles between 480p/480i.

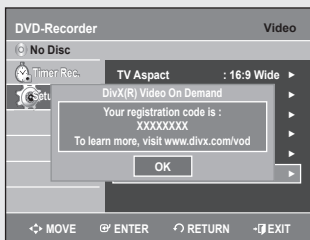

## DivX(R) Registration

*Please use the Registration code to register your DVD Recorder with the DivX(R) Video On Demand format. To learn more, visit [www.divx.com/vod](http://www.divx.com/vod)*



## Parental Control

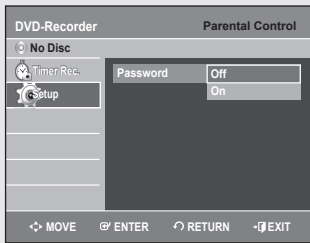

The Parental Control function works in conjunction with DVDs that have been assigned a rating - which helps you control the types of DVDs that your family watches. There are up to 8 rating levels on a disc.

1. With the unit in Stop mode/No Disc mode, press the **MENU** button on the remote control.
2. Select **Setup** using the **▲▼** buttons, then press the **ENTER** or **▶** button.
3. Select **Parental Control** using the **▲▼** buttons, then press the **ENTER** or **▶** button.
4. The first time the Parental Control is accessed, the 'Create the Password' message will be displayed. Create a 4-digit password using the 0 to 9 buttons on the remote control.
5. The "Confirm the password" message will be displayed. Enter your password again using the 0 to 9 buttons on the remote control.
6. Press the **ENTER** or **▶** button, and then select **On** using the **▲▼** buttons. The Parental Control screen appears.

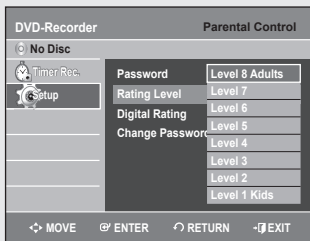

### Setting the Rating Level

1. Select **Rating Level** using the **▲▼** buttons.
2. Press the **ENTER** or **▶** button.
3. Select the desired Level you want using the **▲▼** buttons, then press the **ENTER** or **▶** button.  
For example, if you select up to Level 6, discs that contain Level 7, 8 will not play. A higher number indicates that the program is intended for adult use only.

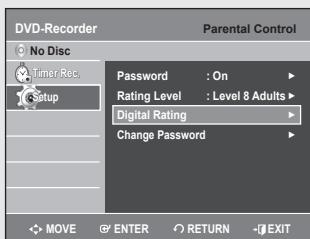

### Setting the Digital Rating

You can set the rating level for Digital channels received by this unit.

1. Select **Digital Rating** using the **▲▼** buttons, then press the **ENTER** or **▶** button.
2. Press the **▲▼** button to select "Digital Rating", then press the **ENTER** button.

If information is not downloaded from the broadcasting station, the Digital Rating menu is deactivated.

Parental restriction information is automatically downloaded while watching DTV channels. It may take several seconds.

The Digital Rating menu is available for use after information is downloaded from the broadcasting station. However, depending on the information from the broadcasting station, it may not be available for use.

- Digital Rating Lock : select **On** using **▲▼** to use Digital rating.
- Downloadable U.S. Rating : select the rating title and the rating value. ex.)

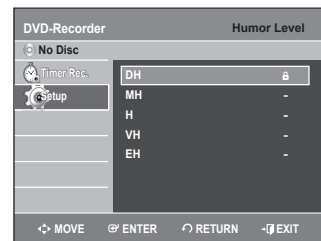
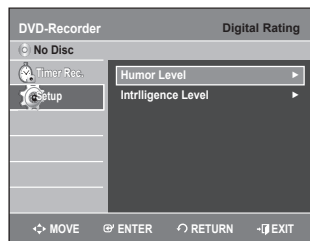
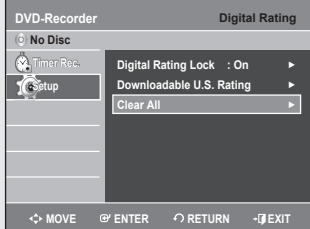
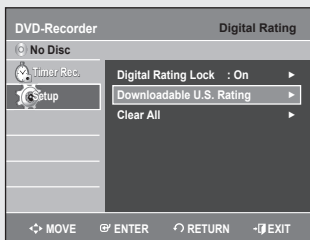

The rating titles (for example: Humor Level..etc) and TV ratings (for example: DH,MH,H..etc) may differ depending on the broadcasting station.

- Clear All : select **Yes** to delete the downloaded data.

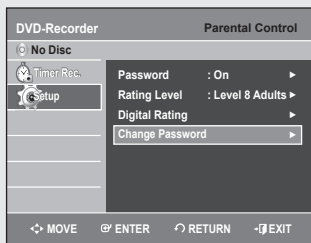

- You can independently lock the ratings. The locked ratings are indicated by the symbol (  ). To unlock a locked rating, press the **ENTER** button again.
- Parental restriction levels differ depending on the broadcasting station.
- The rating titles (For example : Humor level..etc) and values (For example : DH,MH..etc) are changed depending on the downloaded information.
- Generally, the Digital Broadcast parental lock system uses the U.S. or Canadian Rating region Table (RRT). It is same as 'V-Chip' system for Analog Broadcasts.

## Changing the Password

1. Select **Change Password** using the **▲ ▼** buttons.
2. Press the **ENTER** or **▶** button.  
The "Enter the password" message will be displayed.
3. Enter the 4-digit password using the 0 to 9 buttons on the remote control.
4. The "Confirm the password" message will be displayed.  
Enter your password again using the 0 to 9 buttons on the remote control.



- If you forgot your password, remove the disc. Press the **CH** (**▲ / ▼**) buttons on the front panel of the DVD Recorder simultaneously for 5 seconds or more when the power is on. All settings including the password will revert to the factory settings.

## EPG-Electronic Program Guide

*The electronic program guide gives you information on available programs.*

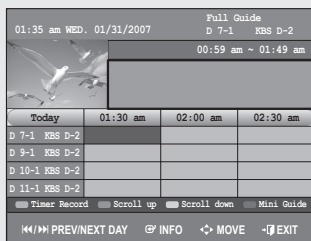

1. Press the **EPG** button while you are viewing a program. (DTV)
  - **RED button (Timer Record)** : Setting the Timer Record or delete.
  - **GREEN button (Scroll Up)** : Scrolls up through the guide.
  - **YELLOW button (Scroll Down)** : Scrolls down through the guide.
  - **BLUE button (Full/Mini Guide)** : Toggles between the Full/Mini Guide.
  - **(▶▶)button** : Goes to next day
  - **(◀◀)button** : Goes to previous day
  - **ENTER button (Information)** : View the detail information or change the channel
2. Press the **▲ ▼ ◀ ▶** buttons to select the desired channel, then press the **ENTER** button.



- The EPG function does not support digital cable. Only digital off-air (antenna) channels are supported.

## • Full Guide

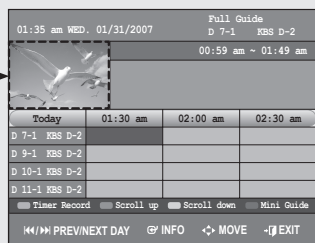

(Sub picture)

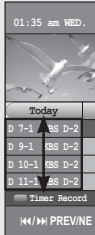

(Channel table)

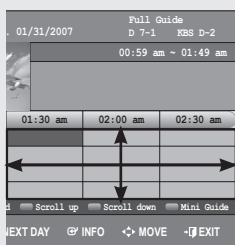

(Time Table)

## • Mini Guide

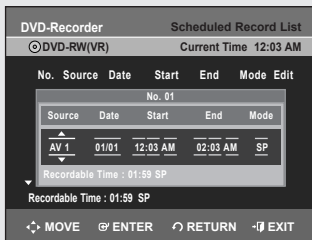
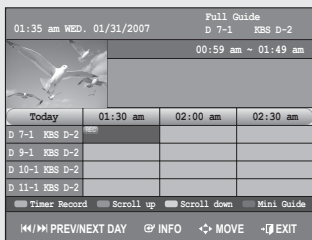
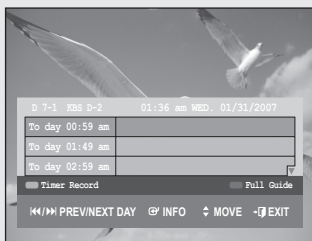

## Viewing Full Guide and Mini Guide

The Full Guide will display programming information for your current channel.

- Press the **BLUE** button to see the Mini Guide.  
If you press this button again, you can return the Full Guide.

### ◆ Full Guide

#### When moving within the Channel table

- The channel/sub picture and EPG information of selected channel is updated by moving up/down.



- Only the currently selected screen information will be displayed on the EPG screen.
- A specific channel must be selected to see updated information on that channel.

#### When moving within the Time Table

- Press the **▲▼◀▶** buttons to select desired Program Title.
- Then press **Enter** button. If the Program Title you have highlighted matches the channel in the sub-picture, you will see detailed program information. If it does not match, pressing **Enter** will change the channel first. You must then press **Enter** again to see the detailed Program info.
- The channel does not change in the sub picture when navigating within the Time Table. You must use the Channel table or press **Enter** after selecting a Program Title.
- EPG information is not updated.
- A maximum of 5 days worth of Program information can be viewed.

### ◆ Mini Guide

- Press the **ENTER** button to see the program information.



- If you press channel up/down button, you can exit EPG screen automatically.

## EPG Timer Recording

Make sure that clock is set before operating this function. (see page 28)

- Press the **EPG** button in Digital Channel mode.
- Press the **▲▼** buttons in the Channel table to select the **Channel** for recording
- Press the **◀▶** buttons in the Time Table to select the desired **Program Title** for recording
- Then press **TIMER (RED)** button. Timer Rec. is setup.
- If you want to cancel the **TIMER REC.** for that program, press one more time.



- You can check this setting scheduled List. (see page 52)  
(Up to 12 recordings can be set for both EPG and regular TV)
- You can change the recording speed. (But you can not change the Date, Time, Source in EPG Recording Mode)
- The time information in the EPG Guide is send from current channel being broadcast.



- If the TV Station sends the wrong time information, Timer recording will fail or the wrong program will be recorded.
- If there is more than 10 minute gap between the current EPG time information and the setting time on this unit, EPG Timer Recording does not work.



# Recording

This section explains various DVD recording methods.

This unit can record on various types of discs. Before recording, read the following instructions and select the disc type according to your preference.

## Recordable discs

This recorder can record on the following types of discs.

DVD-RAM	DVD-RW	DVD-R
RAM	RW	R

- DVD-RWs and DVD-RAMs are rewritable.
- DVD-Rs are non-rewritable

## Compatibility between Samsung and Other manufacturer's Recorders

Disc Types	Recording format	Recording Device	Finalizing	Additional Recording in Samsung Recorder
DVD-RAM	VR Mode	Samsung	X	Recordable
		Other Company	X	Recordable
DVD-RW	VR Mode	Samsung	finalized	Not recordable
			not finalized	Recordable
		Other Company	finalized	Not recordable
			not finalized	Recordable
	V Mode	Samsung	finalized	Not recordable
			not finalized	Recordable
Other Company	V Mode	finalized	Not recordable	
		not finalized	Not recordable	
DVD-R	V Mode	Samsung	finalized	Not recordable
			not finalized	Recordable
		Other Company	finalized	Not recordable
			not finalized	Not recordable



- Finalize
  - This closes the DVD-R/-RW and no additional recording can be done.
- Unfinalize
  - This allows additional recording on a DVD-RW disc originally recorded on the DVD-AR650.
  - A DVD-RW disc that has been recorded by DAO(Disc At once) in a PC cannot be unfinalized.
  - A DVD-RW disc that has been recorded in Video Mode of another manufacturer's recorder cannot be unfinalized.
  - A DVD-R disc cannot be unfinalized.

## DVD-RAM

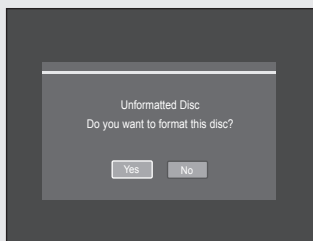

## DVD-RW

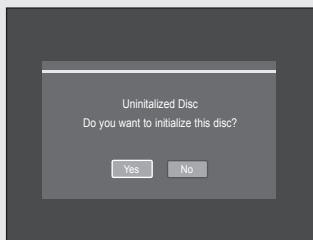

## Recording Formats

*Since available functions differ depending on the disc type, select a disc that best fits your preference. When you insert an unused disc, the following message appears.*

- DVD-RAM : Use after formatting the disc.
- DVD-RW : Use after initializing the disc.  
You can change the VR or V mode of DVD-RW disc. Refer to Formatting a Disc on page 76.
- DVD-R : Formatting disc is unnecessary.

### DVD-RAM/-RW(VR mode)

---

- This mode involves multiple editing functions (such as deletion of the whole title, partial deletion of a title, etc.).
- Various editing options using a created Playlist.

### DVD-RW(Video mode)/-R

---

- Chapters will be created automatically when you finalize recording on DVD-R/DVD-RW discs in Video mode.
- Simple editing (erasing titles/changing title name).



- You can initialize discs automatically using EZ REC MODE. (See page 54)

## Recording Mode

Select one of four record modes by pressing the **REC MODE** button repeatedly for the desired recording time and picture quality while the unit is in **Stop** mode.

In general, picture quality improves as the recording time decreases. In **FR** mode, the most suitable record mode is selected automatically according to the remaining time on the disc and length of the timer recording set.

You can select only one mode from **XP**, **SP**, **LP** and **EP** for timer recording.

Mode	Characteristic	Recording Times Data Rates
<b>XP</b> (high quality mode)	Select when the video quality is important.	Approx. 1 hour about 8 Mbps
<b>SP</b> (standard quality mode)	Select to record in standard quality.	Approx. 2 hours about 4 Mbps
<b>LP</b> (long recording mode)	Select when a long recording time is required.	Approx. 4 hours about 2 Mbps
<b>EP</b> (extended mode)	Select when a longer recording time is required.	Approx. 6 hours/ about 1.2 Mbps Approx. 8 hours/ about 0.8 Mbps
<b>FR</b> (Flexible Recording)	For timer recording only see page 52.	Approx 1 to 8 hours Approx 0.8 to 8Mbps

- Dual layer DVD-Rs have approximately double the capacity of single layer DVD-Rs. (See page 55.)

## Unrecordable Video

Video with copy protection cannot be recorded on this DVD Recorder. When the DVD Recorder receives a copy guard signal while recording, recording stops and the following message appears on the screen.

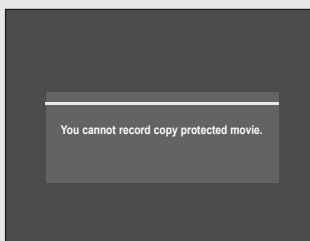

## Concerning Copy Control Signals

TV broadcasts that contain copy control signals may have one of the following three signal types, Copy-Free, Copy-Once and Copy-Never. If you want to record a copy-once type program, use a DVD-RW disc with CPRM in VR Mode. You can also use DVD-RAM discs.

('O' : Supported, '-' : Not Supported)

Signal type Media	Copy-Free	Copy-Once	Copy-Never
DVD-RAM (Ver.2.0)	O	O*	-
DVD-RW (Ver.1.1)	O	-	-
DVD-RW (Ver.1.1) with CPRM VR mode	O	O*	-
DVD-R	O	-	-

When a "Copy Once" recording has been made, recording cannot be done anymore.

\*compatible with CPRM.

### ◆ Content Protection for Recordable Media (CPRM)

CPRM is a mechanism that ties a recording to the media on which it is recorded. It is supported by some DVD recorders, but not by many DVD players. Each blank recordable DVD has a unique 64-bit media ID etched in the BCA(Burst Cutting Area). When protected content is recorded onto the disc, it can be encrypted with a 56-bit C2 (Cryptomeria) cipher derived from the media ID. Disc contents cannot be copied to other media.

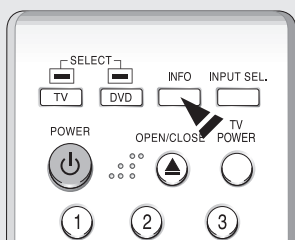

## About the INFO Button

◆ *The INFO function allows you to view the current status and progress of playback and recording. When recording on a used disc, make sure that there is enough disc space for recording.*

◆ *Press the INFO button.*

**The disc information display window appears.**

DVD-RW(VR) Disc Info	
Disc Name	Disc
Total Title	15
Total Playlist	1
Recordable Time	02: 12 SP
Protection	Not Protected
Screen	AV1
JAN 01 2007 MON	12:00 AM

- ① Disc Type
- ② Current information display status
- ③ Disc Name
- ④ Total Title : Total number of titles
- ⑤ Total Playlist : Total number of Playlists
- ⑥ Recordable Time : The longest continuous recording time in each of the record modes(approximate)
- ⑦ Date : Current date
- ⑧ Time : Current time



- Items in the display differ depending on the disc type or the recording format.
- With DVD-RAMs or DVD-RWs, you can free up disc space by erasing titles.
- Press the **INFO** button again with the unit in playback or recording mode, then you can check the current status.



## Recording immediately



### Before you start

◆ **Check that the disc has enough available space for the recording. Adjust the recording mode.**

1. Press the **OPEN/CLOSE** button and place a recordable disc on the disc tray.
2. Press the **OPEN/CLOSE** button to close the disc tray. Wait until "**LOAD**" disappears from the front panel display. If an unused DVD-RW disc is inserted, the message "Uninitialized Disc Do you want to initialize this disc?" will appear. (See page 45)

### Recording the current TV program you are watching

1. Press the **CH** (⏪/⏩) or **number** (0~9) buttons to select the current program you want to record.
2. Press the **REC MODE** button repeatedly, (or press the REC MODE button and then press the **▲▼** button) to select the recording speed (quality).  
 → **SP → LP → EP → XP** →
3. Press the **REC** button.  
 Information concerning the channel is displayed on the screen and then recording begins. Icon(○) is displayed on the front panel.

### Recording from External Equipment



1. Press the **INPUT SEL.** button to select the input source according to the connection you made.  
 The front panel display changes in the following sequence:  
 → **AV1 → AV2 → DV → CH → D-CH** →
2. Press the **REC MODE** button repeatedly, to select the recording speed(quality).  
 → **SP → LP → EP → XP** →
3. Press the **REC** button.

### To pause recording

Press the **REC PAUSE** button to pause a recording in progress.  
 Press the **REC PAUSE** button again to resume recording.

### To stop recording

Press the **STOP** (⏹) button to stop or finish recording in progress.

- When using DVD-RAM/DVD-RW/DVD-R discs, the message 'Updating the information of disc. Please wait for a moment.' is displayed.





- You can not change the recording mode and input source during recording.
- Recording will stop automatically if there is no free space left.
- Up to 99 titles can be recorded onto a DVD-RAM/-RW/-R disc.
- Recording will stop automatically if a copy protected image is selected.
- If you are using a Cable Box(no antenna), you cannot watch a different cable TV program from the one you're recording.
- DVD-RAM/DVD-RW discs must be formatted before starting to record. Most new discs are sold unformatted.
- Do not use DVD-R authoring discs with this unit.

## Copying from a Camcorder

You may control a Digital Camcorder using the IEEE1394 (DV) interface.



### Before you start

**Check that the disc has enough available space for the recording. Adjust the record mode. See page 27 to see how to connect the camcorder to your DVD recorder.**

1. Press the **OPEN/CLOSE** button, and place a recordable disc on the disc tray.
2. Press the **OPEN/CLOSE** button to close the disc tray. Wait until "LOAD" disappears from the front panel display.
3. Press the **REC MODE** button repeatedly to select the recording speed(quality).  
→ **SP** → **LP** → **EP** → **XP**
4. Press the **INPUT SEL.** button to select **DV**.  
If the input is set to **DV**, a playback/record menu that enables Digital camcorder control appears on the top of the screen.
5. Select the **PLAY** (▶) icon on the upper part of the screen to playback the camcorder and find the starting position to copy.
6. To start recording, select **REC** (●) icon in the top side of the screen using the ◀ ▶ buttons, then press the **ENTER** button.

### To stop recording

Press the **STOP** (⊕) button to stop or finish recording in progress.

- When using DVD-RAM/DVD-RW/DVD-R discs, the message 'Updating the information of disc. Please wait for a moment' is displayed.



- You can not change the record mode and input source while recording.
- Recording will stop automatically if there is no free space left.
- Up to 99 titles can be recorded onto a DVD-RAM/-RW/-R disc.
- DVD-RAM/DVD-RW discs must be formatted before starting to record. Most new discs are sold unformatted.
- Do not use DVD-R authoring discs with this unit.
- To access on-screen controls during recording, press the ◀ or ▶ buttons.
- When copying from a camcorder and the end of the recorded content is reached (no Video), the screen may turn blue or purple.
- IEEE1394 : A very fast external bus standard that supports data transfer rates of up to 400Mbps (in 1394a) to transfer high levels of data in real-time, such as video devices.



## Making a One Touch Recording (OTR)



*You can set the DVD Recorder to record in preset increments by pressing the REC button repeatedly.*

1. If you want to record from a connected external component, press the **INPUT SEL.** button to select an appropriate external input (AV1, AV 2 or DV, CH, D-CH).
2. Press the **REC** button to start recording.
3. Press the **REC** button to adjust the recording time.

→ 0:30 → 1:00 → 1:30 → 2:00 → 3:00 → 4:00 → off



- The timer counter decreases to 0:00, then the DVD Recorder stops recording.  
After finishing recording, the DVD Recorder will turn off automatically.

### To stop recording

Press the **STOP** (⏏) button. The message "Press STOP button once more to cancel Timer Record." is displayed.

Press the **STOP** (⏏) button again to stop recording.

## Setting a Timer Recording

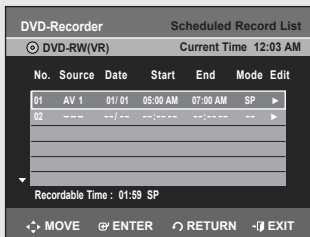

**You need to set the Clock (Setup – Clock Set) before proceeding with a timer recording. (See page 29)**

1. Press the **OPEN/CLOSE** button, and place a recordable disc on the disc tray.
2. Press the **OPEN/CLOSE** button to close the disc tray. Wait until "LOAD" disappears from the front panel display. If an unused DVD-RW disc is inserted, whether to initialize or not will be asked first. (See page 45)
3. Press the **MENU** button in Stop mode.
4. Press the **▲▼** buttons to select **Timer Rec.**, and then press the **ENTER** or **▶** button.
5. Press the **▲▼** buttons to select **Timer Record**, and then press the **ENTER** or **▶** button.  
The Timer Record Input items are displayed.  
You can also set a timer recording via the **TIMER** button.
6. Fill in the items using the **▲▼◀▶** buttons.
  - ◀▶ : Moves to the previous/next item,
  - ▲▼ or 0~9 : To set or change items in the Scheduled Record List Menu.
  - **Source**: Select the video input source (AV 1, AV 2, CH, D-CH) you want to make a timer recording of.
  - **Date**: Date that the timer recording starts  
- There are three options when setting the date. See below:
    - ① To make a recording on a specific date, press the **▲▼** or number buttons until the date you want appears.
    - ② To make a recording at the same time every day (Monday to Friday), press the **▲▼** buttons until MON-FRI appears.
    - ③ To make a recording on a specific day of the week (ie Mon, Tues etc), press the **▲▼** buttons until 'Every SAT'...'Every SUN' appears.
  - **Start/End Time**: Start and end time of the timer recording
  - **Mode (Record mode)**
    - XP : Approx. 1 hour
    - SP : Approx. 2 hours
    - LP : Approx. 4 hours
    - EP : Approx. 6 hours or 8 hours
    - FR : See page 51.
7. Press the **ENTER** button.
  - (⊕) and Timer Set will appear on the front panel display. This means that a timer recording is set.
  - Recording is automatically performed when the set time is reached.



- When you are recording at EP mode on a DVD-RW(V)/-R disc, it may not record the full 6 or 8 hours because the unit uses the VBR(Variable Bit Rate) ENCODING system. For example, if you record a Program with a lot of action, it uses a higher bit rate which in turn consumes more disc memory.



#### ■ If the timer settings overlap

The first program has priority. After recording of the first program is complete, the second program starts being recorded.

- The timer recording time may differ from the set time depending on the disc and the overall timer recording status (for example, recording times overlapping, or when the previous recording ends within 3 minutes of the start of the next recording.)
- ⌚ will start blinking if Timer Recording is not ready to start.

## Flexible Recording (for Timer Recording only)



*In FR mode, the most suitable recording mode is selected automatically, according to the remaining time on the disc and the length of the timer recording set.*

*The FR mode recording setup is the same as Timer Recording setup. When setting the Rec mode in step 6, select FR Mode. (See page 51)*

## Editing the Scheduled Record List



*You can change timer record settings using the scheduled record list menu.*

1. Press the **MENU** button in **STOP** mode.
2. Press the **▲▼** buttons to select **Timer Rec.**, and then press the **ENTER** or **▶** button.
3. Press the **▲▼** buttons to select **Scheduled Record List**, and then press the **ENTER** or **▶** button.
4. Press the **▲▼** buttons to select the number of the Scheduled Record List you want to edit, and then press the **ENTER** or **▶** button. The Edit and Delete items are displayed.
5. Press the **▲▼** buttons to select **Edit**, and then press the **ENTER** or **▶** button. The Timer Record Input item is displayed. Edit the items you want to modify. See the Timer Record section for more information on Timer Record Input items. (See page 50)
6. Move through the items with the **◀▶** buttons and change the settings with **▲▼** or number buttons and press the **ENTER** button.
7. Press the **EXIT** button after the operation is finished. The menu screen will disappear.

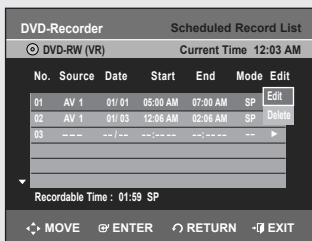
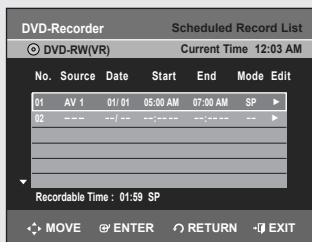

## Deleting the Scheduled Record List

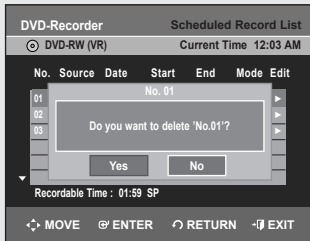

*You can delete timer record list using the scheduled record list menu.*

1. Press the **MENU** button in Stop mode.
2. Press the **▲▼** buttons to select **Timer Rec.**, and then press the **ENTER** or **▶** button.
3. Press the **▲▼** buttons to select **Scheduled Record List**, and then press the **ENTER** or **▶** button.
4. Press the **▲▼** buttons to select the number of the timer recording you want to delete, and then press the **ENTER** or **▶** button. The Edit and Delete items are displayed.
5. Press the **▲▼** buttons to select **Delete**, and then press the **ENTER** or **▶** button.
6. Press the **◀▶** buttons to select **Yes**, and then press the **ENTER** button. The selected entry will be deleted from the list.



- You can not delete programs that are currently being recorded.

## Recording the Scheduled Record List

*When the start time in the Scheduled Record List is reached while the unit is powered off, the unit will automatically power on and start recording.*

1. When the scheduled recording is operating, the program being recorded will not display on TV.
  - Power on TV using the TV remote control.
  - Power off TV using the TV remote control if you don't want to see the program being recorded.

### To stop recording

Press the **STOP (⊕)** button. The message "Press STOP button once more to cancel Timer Record." is displayed.

Press the **STOP (⊕)** button again to stop recording.



- If a copy protection signal is received during recording, recording will stop.
- If there is no free disc space or the disc is not recordable, recording will not operate. (You can record after replacing the disc.)

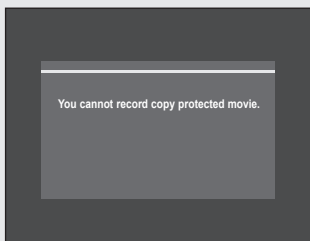
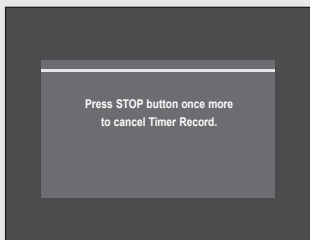

## EZ REC MODE

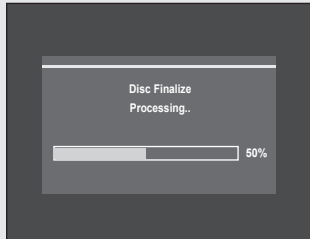
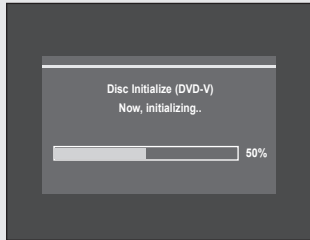
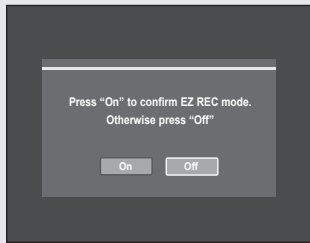

*This function allows you to **Initialize and Finalize a disc automatically.***

1. With the unit in Stop/No Disc mode, press the **EZ REC MODE** button on the remote control.
2. Press the ◀ ▶ buttons to select **On**, and then press the **ENTER** button.  
The EZ REC MODE is set up.
3. Insert a disc.  
If the disc is new, it will initialize automatically.
4. Press the **REC** button.
5. EZ REC MODE will Automatically Finalize the disc under the following conditions.  
After the disc is finalized, it will play in most DVD players/drives.

- When you press the **OPEN/CLOSE** button on your DVD Recorder after recording on at least 30% of the disc. The tray will open after the disc has been finalized.
- When the disc is full, it will finalize automatically and the Recorder will remain in stop mode.
- When you make a timer recording and it occupies at least 30% of the disc, the disc will finalize automatically and the Recorder will power off. Please note that auto finalization will not work if the Recorder has more than one Timer Recording set in the Scheduled Record List.



- If you insert a new DVD-RW disc, it will be formatted in V mode after auto initializing.
- If you select off, you must initialize (see page 45) and finalize the disc manually in the Disc Manager menu.(see page 77)
- The length of Recording is different according to recording mode. (see page 46)



# Playback

This section introduces basic playback functions and playback by disc type.

Read the following information before playing a disc.

## Region code (DVD-Video only)



Both the DVD recorder and the discs are coded by region. These regional codes must match in order for the disc to play. If the codes do not match, the disc will not play. The Region Number for this recorder is described on the rear panel of the recorder.

## Logos of Discs that can be played

Dolby Digital	DTS	Digital Audio
Stereo	NTSC broadcast system in U.S.A, Canada, Korea, Japan, etc.	
DivX	MP3	

## Disc types that can be played

Disc Types	Disc Logo	Recorded content	Disc Shape	Max. Playing Time
DVD-VIDEO		VIDEO AUDIO	Single sided(5")	240min
			Double sided(5")	480min
			Single sided(3.5")	80min
			Double sided(3.5")	160min
AUDIO-CD		AUDIO	Single sided(5")	74min
			Single sided(3.5")	20min
JPEG		JPEG Images	Single sided(5")	-
			Single sided(3.5")	-
MP3		MP3 Audio	Single sided(5")	-
			Single sided(3.5")	-
MPEG4		MPEG4 Movie	Single sided(5")	-
			Single sided(3.5")	-
DVD-RAM		VIDEO AUDIO	Single sided(5") (4.7GB)	1hr (XP: Excellent Quality) 2hrs (SP: Standard Quality) 4hrs (LP: Long Playback) 6 or 8hrs (EP: Extended)
			Double sided(5") (9.4GB)	2hr (XP: Excellent Quality) 4hrs (SP: Standard Quality) 8hrs (LP: Long Playback) 12 or 16hrs (EP: Extended)
DVD-RW		VIDEO AUDIO	5" (4.7GB)	1hr (XP: Excellent Quality) 2hrs (SP: Standard Quality) 4hrs (LP: Long Playback) 6 or 8hrs (EP: Extended)
DVD-R		VIDEO AUDIO	Single Layer(5") (4.7GB)	1hr (XP: Excellent Quality) 2hrs (SP: Standard Quality) 4hrs (LP: Long Playback) 6 or 8hrs (EP: Extended)
			Dual Layer(5") (8.5GB)	2hr (XP: Excellent Quality) 4hrs (SP: Standard Quality) 8hrs (LP: Long Playback) 11 or 15hrs (EP: Extended)

## Discs That Cannot be Played

- DVD-Video with a region number other than “1” or “ALL”
- 5” 2.6 GB and 5.2 GB DVD-RAM
- 3.9 GB DVD-R Disc for Authoring.
- A DVD-R/DVD-RW(V) disc which has been recorded and not finalized in a different manufacturer’s recorder.
- PAL discs
- DVD-ROM/PD/MV-Disc, etc.
- Video CD/CVD/SVCD/CD-ROM/CDV/CD-G/CD-I



- This DVD recorder can only operate with discs that are compatible with DVD-RAM Standard Version 2.0.
  - Playback and/or recording may not work for some types of discs, or when specific operations, such as angle change and aspect ratio adjustment, are being performed. Information about the discs is written in detail on the box. Please refer to this if necessary.
  - Do not allow the disc to become dirty or scratched. Fingerprints, dirt, dust, scratches or deposits of cigarette smoke on the recording surface may make it impossible to use the disc for recording.
  - DVD-RAM/-RW/-R discs may not be able to play on some DVD players, depending on the player, disc and the condition of the recording.
  - Discs with PAL programs already recorded on them can not be recorded on using this product.

## Playing a Disc

1. Press the **OPEN/CLOSE** button.  
The tray opens.
2. Place a disc gently into the tray with the disc’s label facing up.  
For DVD-RAM discs, insert the printed side facing up.
3. Press the **OPEN/CLOSE** button to close the disc tray.
  - Your DVD Recorder closes the disc tray and loads the disc automatically.
  - When the recorder is powered on and a disc is in the tray, the unit will be activated and wait in Stop mode.
  - Press the **PLAY** (▶) button to start playback.
  - If you want the unit to play automatically when it is powered off with a disc in the unit, power on with the **PLAY** (▶) button.
4. Press the **STOP** (⏏) button to stop playback.



- When you stop playing the disc, the recorder remembers where you stopped. When you press the PLAY button again, it will pick up where you left off. (unless the disc is removed, the recorder is unplugged, or if you do not press the STOP button twice.) This function is only applicable to DVD-VIDEO, DVD-RAM, DVD-RW, DVD-R or audio CDs (CD-DA).



- Do not move your DVD recorder while playing, as this may cause damage to the disc.
- Make sure to press the OPEN/CLOSE button to open or close the disc tray.
- Do not push the disc tray while it is being opened or closed, as this may cause a product malfunction.
- Do not place foreign materials on or in the disc tray.
- Some functions may perform differently or be disabled depending on the disc type. If this occurs, refer to the instructions written on the disc case.
- Be especially careful that children’s fingers are not caught between the disc tray and the tray chassis when it closes.
- You must only insert one DVD disc at a time. Inserting two or more discs will not allow playback and may cause damage to the DVD player.



## Using the Disc Menu & Title Menu

Some discs contain a dedicated menu system that allows you to select special functions for the title, such as chapters, audio track, subtitles, film previews, information on characters, etc.

### For DVD-VIDEO Discs



**Disc Menu** : Press the **DISC MENU** button to enter the disc's menu.

- Move to the setup menu related to the playback operation.
- You can select the audio language and the subtitles provided by the disc.

**Title Menu** : Press the **TITLE MENU** button to move to the title menu of the disc.

- Use this button if the disc contains more than one title. Some type of discs may not support the title menu function.

### For DVD-RAM/DVD±RW/±R Discs



**Title List** : Press the **TITLE LIST** button. The Title List is simply a list of titles on a disc. If a title is deleted, that title cannot be played again.

**PLAY LIST** : Press the **PLAY LIST** button. A playlist is a custom-made list of titles. When one playlist is played, only the titles within the playlist will play and then stop. Even if that playlist is deleted, the original recording will not be deleted. (only VR mode)

## Using the Playback Related Buttons



### Searching through a Chapter or Track

DVD-VIDEO/ DVD-RAM/ DVD-RW/DVD-R	►► Fast 1(X 2) → ►► Fast 2(X 4) → ►► Fast 3(X 8) → ►► Fast 4(X16) → ►► Fast 5(X 32) → ►► Fast 6(X128) → ►► Fast 1(X 2)
MPEG4	►► Fast 1 → ►► Fast 2 → ►► Fast 3 → ►► Fast 1
AUDIO CD (CDDA)	►► Fast ×2 → ►► Fast ×4 → ►► Fast ×8 → ►► Fast ×2

During playback, press the **SEARCH**( ◀▶ ) button on the remote control.

- You can scan the program in reverse.
- Press and hold the **SEARCH**( ◀▶ ) button, playback is done at the default speed of fast 2.
- If you release the **SEARCH**( ◀▶ ) button, playback is performed at normal speed.(Except CD-DA)
- To return to normal playback speed, press the **PLAY**( ▶▶ ) button.





- No sound is heard during Scan(Search) mode except 'Fast 1' search mode (X1.7 speed audio).
- For CD(CD-DA), You can hear sound during Scan mode.
- You cannot hear audio while scanning an MPEG4.
- The speed marked while scanning may be different from the actual playback speed.

## Searching Chapters or Tracks

During playback, press the **SKIP** (⏮ ⏭) button on the remote control.

- If you press the **SKIP** (⏮) button, it moves to the beginning of the chapter or track or marker (DVD-RAM,DVD-RW(VR mode).) Pressing the button once again within 3 seconds returns to the beginning of the previous chapter or track or marker (DVD-RAM, DVD-RW(VR mode).)
- If you press the **SKIP** (⏭) button, it moves to the next chapter or title or marker (DVD-RAM,DVD-RW (VR mode).)

## Slow Motion Play



In Pause mode, press the **SEARCH** (⏮) button on the remote control.

- If you press the **SEARCH** (⏮) button,

▶▶ Slow 1 → ▶▶ Slow 2 → ▶▶ Slow 3

- If you press the **SEARCH** (⏭) button,

▶◀ Slow 1 → ▶◀ Slow 2 → ▶◀ Slow 3

- Press and hold the **SEARCH** (⏮) button during pause, and the disc will play slowly at a 1/2 speed. If the button is released, the pause operation will resume.
- To return to normal speed playback, press the **PLAY** (⏪) button.



- The speed marked in this function may be different from the actual playback speed.
- Slow motion operates only in the forward direction on MPEG4 discs.

## Step Motion Play



Press the **STEP** (⏮ ⏭) button on the remote control in the still mode.

- Each time the button is pressed, a new frame will appear.  
**If you press the STEP** (⏮) **button**, the previous frame will be activated.  
**If you press the STEP** (⏭) **button**, the next frame will be activated.
- To return to normal speed playback, press the **PLAY** (⏪) button.



- Step motion operates only in the forward direction on MPEG4 discs.

## Using the ANYKEY Button

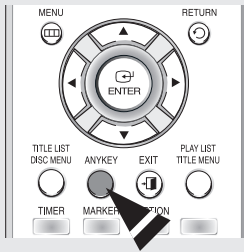

The **ANYKEY** function allows you to easily search for a desired scene by accessing title, chapter, track, and time. You can also change the subtitle and audio settings and set some features including Repeat, Angle, and Zoom.

## Moving to a Desired Scene Directly



If you want to move to a certain title, chapter or time use this function.

1. Press the **ANYKEY** button during playback.
2. Press the **▲▼** buttons to select the Title, Chapter or Time.
3. Press the **◀▶** buttons or number (0~9) buttons to select the desired scene and then press the **ENTER** button.  
In case of searching a time, Enter the time in the sequence of hours, minutes, seconds using the number buttons. **◀▶** are not available.



- The Time Search function does not operate with some discs.
- To make the screen disappear, press the **ANYKEY** again.



## Playing Repeatedly

1. Press the **ANYKEY** button during playback.
2. Press the **▲▼** buttons to select **Repeat** and press the **◀▶** buttons to select the **Title** or **Chapter** you want to play repeatedly.
3. Press the **ENTER** button.



- DVD-RAM, DVD-RW(VR mode), unfinalized DVD-R and unfinalized DVD-RW (Video mode) do not repeat a chapter.



## Playing a Certain Section Repeatedly



1. Press the **ANYKEY** button during playback.
2. Press the **▲▼** buttons to select **Repeat** and press the **▶** button to select **A-B**.
3. Press the **ENTER** button.
4. Press the **ENTER** button at the point where you want the repeat play to start (A) and press it again at the point where you want the repeat play to stop (B).  
Repeat playback of the A-B section starts.



- If you set point (B) before five seconds has lapsed, the prohibition mark (⊘) will appear.
- You can also activate Normal Playback by pressing the **CANCEL** button.
- Audio CDs(CD-DA) and MP3 discs do not support the Repeat A-B function.



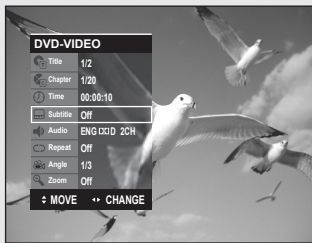

## Selecting the Subtitle



**Subtitle languages may not work depending on the disc type. This is only available during playback.**

1. Press the **ANYKEY** button during playback.
2. Press the **▲▼** buttons to select **Subtitle** and press the **◀▶** buttons to select the desired subtitle language.



- If the subtitles overlap, disable the caption function on your TV.
- Some discs allow you to select the language for the disc menu only.
- To make the screen disappear, press the **ANYKEY** again.

## Selecting the Audio language



**Audio languages may not work depending on the disc type. This is only available during playback.**

1. Press the **ANYKEY** button during playback.
2. Press the **▲▼** buttons to select **Audio** and press the **◀▶** buttons to select the desired audio language.



- Audio languages may be different because they are disc-specific.
- Some discs allow you to select the audio language for the disc menu only.
- To make the screen disappear, press the **ANYKEY** again.

## Using One Touch button

**By pressing the Audio button, you can access the Audio function directly.**

## Changing the Camera Angle



**When a DVD-VIDEO contains multiple angles of a particular scene, you can select the Angle function.**

**This is only available during playback.**

**If the disc contains multiple angles, the ANGLE mark appears on the screen.**

1. Press the **ANYKEY** button during playback.
2. Press the **▲▼** buttons to select **Angle** and press the **◀▶** buttons or number(0~9) buttons to select the desired angle.



- This function is disc-dependent, and may not work all DVDs.
- This function does not work when a DVD has not been recorded with a multicamera angle system.
- To make the screen disappear, press the **ANYKEY** again.



## Zooming-In



1. Press the **ANYKEY** button during playback or pause.
2. Press the **▲▼** buttons to select **Zoom**, and then press the **ENTER** button.  
( **Ⓚ** ) will be displayed.
3. Press the **▲▼◀▶** buttons to move to the area you want to enlarge.
4. Press the **ENTER** button.  
**normal size** → **2X** → **4X** → **2X** → **normal size**

## Using Bookmarks

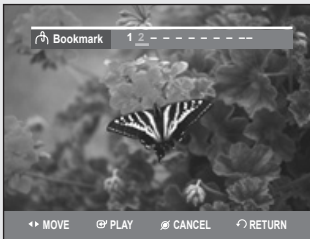

*This feature lets you bookmark sections of a DVD or DVD-R/-RW (V mode), so you can quickly find them.*

### ◆ Setting Bookmarks

1. Press the **MARKER** button during playback.
2. Press the **MARKER** button during playback. Press the **ENTER** button when the desired scene appears.  
The number 1 is displayed and the scene is memorized.
3. Press the **◀▶** button to move to the next position.
4. Press the **ENTER** button when the desired scene appears.  
The number 2 is displayed and the scene is memorized.
  - Repeat above to bookmark other positions.
  - You can bookmark up to 10 scenes.



- When the disc tray is opened and then closed, bookmarks will disappear.
- The button display may differ depending on the disc type.

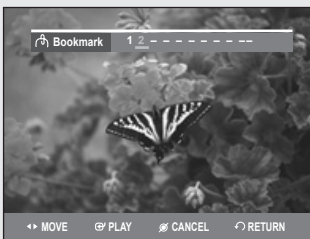

### ◆ Playing Back a Bookmark

1. Press the **MARKER** button during playback.
2. Press the **◀▶** buttons to select a bookmarked scene.
3. Press the **ENTER** or **PLAY** ( **▶** ) button to start playing from the selected scene.

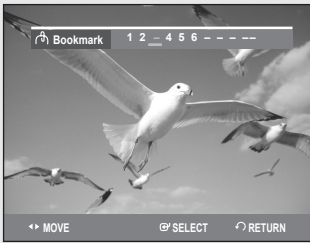

#### ◆ Clearing a bookmark

1. Press the **MARKER** button during playback
2. Press the ◀ ▶ buttons to select a bookmarked scene.
3. Press the **CANCEL** button to delete the selected bookmark.

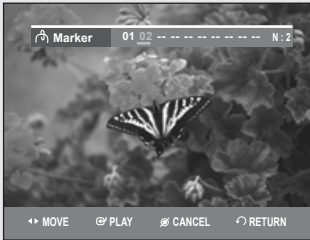

### Using Markers



(VR mode)

#### ◆ Setting Markers

1. Press the **MARKER** button during playback.
2. Press the **ENTER** button when the desired scene appears.  
The number 01 is displayed and the scene is memorized.
3. Press the ◀ ▶ button to move to the next position.
4. Press the **ENTER** button when the desired scene appears.  
The number 02 is displayed and the scene is memorized.
  - DVD-RAM or DVD-RW (VR Mode) discs have the Marker function instead of the Bookmark function.  
The Marker function allows you to mark up to 99 scenes. Since the scenes may be displayed as many different pages, numbering is necessary.  
If a disc in use is encoded with Disc Protect, Markers cannot be set or deleted. Only playback is available.

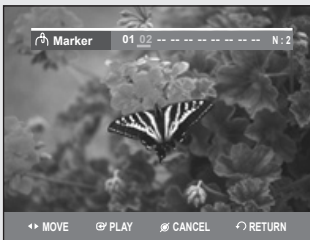

#### ◆ Playing Back a Marker

1. Press the **MARKER** button during playback.
2. Press the ◀ ▶ buttons to select a bookmarked scene.
3. Press the **ENTER** or **PLAY** (▶) button to start playing from the selected scene.
  - If you press the **SKIP** (⏮) button, it moves to the beginning of the marker. Pressing the button once again within 3 seconds returns to the beginning of the previous marker.
  - If you press the **SKIP** (⏭) button, it moves to the next marker.



#### ◆ Clearing a Marker

1. Press the **MARKER** button during playback.
2. Press the ◀ ▶ buttons to select a bookmarked scene.  
Press the **CANCEL** button to delete the selected bookmark.
  - When a marker is cleared while DVD-RAM/DVD-RW(VR mode) is playing, marker numbers will change. For example, if the 7th marker is cleared after ten markers are registered, the marker numbers after the eighth will automatically move ahead by one and the 8th marker becomes the 7th.

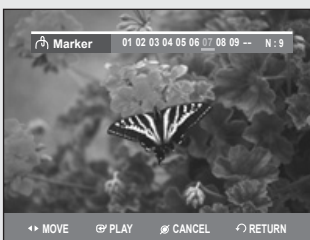

## Playing an Audio CD/MP3

### Buttons on the Remote Control Used for CD Playback

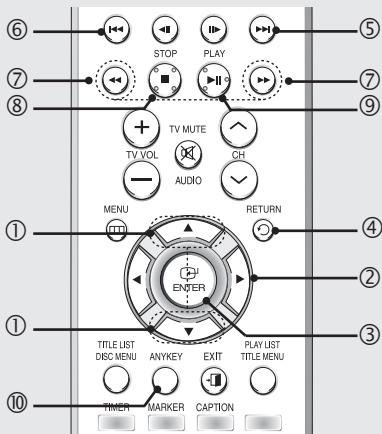

- ① ▲▼ : Selects a track (song).
- ② ► : Plays the selected track (song).
- ③ **ENTER** (⏏) button : Plays the selected track (song).
- ④ **RETURN** (⌂) button: Moves to the folder to which the current song belongs.
- ⑤ **SKIP** (⏭) button : Plays the next track.
- ⑥ **SKIP** (⏮) button : Returns to the beginning of the current track when pressed during playback. If pressed again, your DVD recorder moves to and plays the previous track. If you press this button within three seconds after playback starts, the previous track will be played. If you press this button after three seconds, the current track will be replayed from the beginning.
- ⑦ **SEARCH** (⏮/⏭) button : Fast Play (X2, X4, X8)
- ⑧ **STOP** (⏏) : Stops a track(song).
- ⑨ **PLAY/PAUSE** (⏮/⏭) : Plays a track(song) or pauses playback.
- ⑩ **ANYKEY**: To select the sub menu on screen display (Repeat or Play Option).

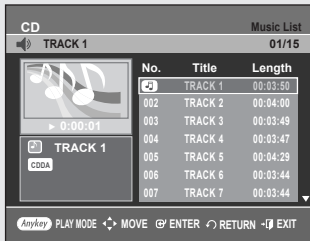

### Playing an Audio CD(CD-DA)

1. Insert an audio CD (CD-DA) into the disc tray.  
The audio CD menu appears and the tracks (songs) are played automatically.
2. Press the ▲▼ buttons to select the track you want to hear, and then press the **ENTER** button or ► button.

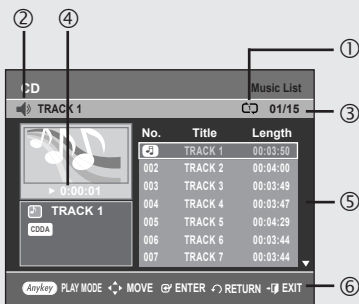

#### ◆ Audio CD(CD-DA) Screen Elements

- ① **PLAY MODE icon**
- ② **Current track (song)** : Displays the number of the track currently being played.
- ③ Displays the current play index and total track number.
- ④ Shows the operating state of a disc and the current playback time.
- ⑤ Displays the track list (song list) and the playing time of each track.
- ⑥ Button display.

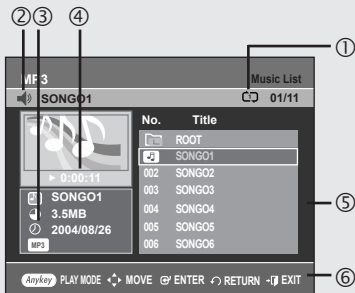
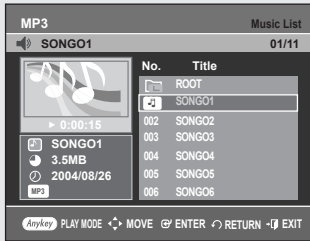

## Playing an MP3 Disc

1. Insert an MP3 disc into the disc tray.  
Press the ▲▼ buttons to select **Disc Navigation**, and then press the **ENTER** or ► button.
2. Press the ▲▼ buttons to select **Music**, and then press the **ENTER** or ► button.  
The MP3 menu appears and the tracks(songs) are played automatically.
3. Press the ▲▼ buttons to select the track (song) you want to hear, and then press the **ENTER** button or ► button.

### ◆ MP3 Screen Elements

- ① **PLAY MODE** icon
- ② **Current track (song)** : Displays the name of the track being played.
- ③ MP3 file information.
- ④ Shows the operating state of a disc and the current playback time.
- ⑤ Displays the information for the folder and its tracks.
- ⑥ Button display.

## Playing Repeatedly



1. Press the **ANYKEY** button during playback. The play mode window appears.
2. Select the desired repeat mode using ◀▶ buttons, and then press the **ENTER** button.
  - **Track** : Selected track is played repeatedly.
  - **Disc** : Inserted disc is played repeatedly.
  - **Folder(mp3 only)** : Tracks in the current folder are played repeatedly.

### To return to normal playback

3. Press the **CANCEL** button to return to normal playback.



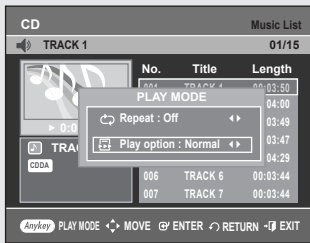

## Play Option Mode

- During Stop, Press the **ANYKEY** button. The Play option will be highlighted.
  - During Playback, Repeat Mode will be highlighted.
- Select a desired play option (Normal, Random, Intro or Playlist) using the ◀ ▶ buttons. Press the **ENTER** button.
  - Normal** : Tracks on a disc are played in the order in which they were recorded on the disc.
  - Random[R]** : The Random option plays the disc's tracks in random order. After a random list is generated and played completely, another random list is generated and played. Random Play is continued until the play option is changed.
  - Intro[I]** : The first 10 seconds of each track will be played. If you want to listen to the music that you have selected, press the **ENTER** button or **PLAY** (⏮) button. The play option will be changed to Normal Play. When Intro Play is completed, Normal Play is performed.
  - Playlist** : The Playlist playback option allows you to select the order in which you want tracks to play.

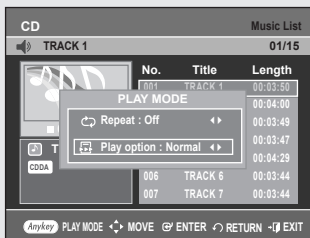

## To Program Tracks

*You can register a maximum of 30 tracks in the playlist.*

- During Stop, Press the **ANYKEY** button. The Play option will be highlighted.
  - During Playback, Repeat Mode will be highlighted.
- Select **Playlist** using the ◀ ▶ buttons, and then press the **ENTER** button. The Playlist screen will appear. Select tracks in the order in which you want them to play using the ▲ ▼ buttons. Press the **ENTER** button. If there is a track on your playlist you wish to remove. Press the ▶ button, then press the ▲ ▼ buttons to select the track you wish to remove, then press the **CANCEL** button. The selected track will be removed.
- Press the **PLAY** (⏮) button to playback the playlist.

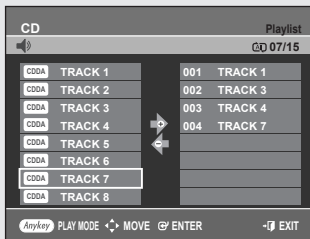

## Playing a Picture CD

- Insert an JPEG disc into the disc tray.
- Press the ▲ ▼ buttons to select **Disc Navigation**, and then press the **ENTER** or ▶ button.
- Press the ▲ ▼ buttons to select **Photo**, and then press the **ENTER** or ▶ button.
- Press the ▲ ▼◀▶ buttons to select a picture.
  - To see the next 8 pictures, press the **SKIP** (⏭) button.
  - To see the previous 8 pictures, press the **SKIP** (⏮) button.

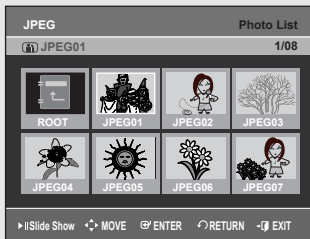

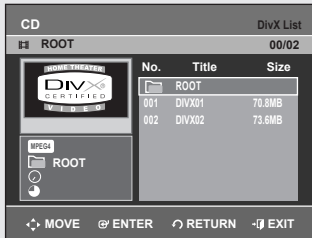

5-1. If you press the **PLAY** (▶) button, the Slide show screen will appear. The picture interval (Slide show speed) must be set.

5-2. Press the **ENTER** button with a picture selected in the Album screen and select a display mode (**Album screen** (☐), **Slide show** (▶), **Rotation** (↻) or **Zoom** (🔍)) using the ◀▶ buttons, then press the **ENTER** button.

☐ : Returns to the Album screen.

▶ : The unit enters slide show mode.

Before the slide show can begin, the picture interval (Slide show speed) must be set.

↻ : Each time the **ENTER** button is pressed, the picture rotates 90 degrees clockwise.

🔍 : Each time the **ENTER** button is pressed, the picture is enlarged up to 4X. (**Normal** → **2X** → **4X** → **2X** → **Normal**)

• Press the **ANYKEY** button to display or clear menus.

## Playing an MPEG4 Disc



*An MPEG4 File is used to contain audio and video data.*

1. Insert a MPEG4 Disc into the disc tray.
2. Press the ▲▼ buttons to select the **Disc Navigation**, and then press the **ENTER** or ▶ button.
3. Press the ▲▼ buttons to select the **DivX**, and then press the **ENTER** or ▶ button.
4. Press the ▲▼ buttons to select the avi file (DivX), then press the **ENTER**, ▶ or **PLAY** button.
5. When an MPEG4 file is being played, you can use the following functions. Pressing the **STOP** button once during playback will display the file list, pressing the button again will exit the menu screen.

### ◆ MPEG4 Function Description

Function	Description
Skip Scene	During playback, press the <b>SKIP</b> (⏮ or ⏭) button, it moves forward or backward 5 minutes.
Search Scene	During playback, press the <b>SEARCH</b> (⏪ or ⏩) button and press again to search at a faster speed. (Fast1, Fast2, Fast3)
Slow Motion	In pause or step mode, press the <b>SEARCH</b> (⏪) button on the remote control. (Slow1, Slow2, Slow3)
Step Motion	Press the <b>STEP</b> (⏪) button on the remote control in still mode.



- This DVD Recorder can play the following video compression formats, -MPEG4 Codec format :DivX 3.11 DivX 4.x DivX 5.x -Audio format :.MP3,.MPEG,.PCM,.AC3,.DTS
- Supported subtitle file formats:.smi,.srt,.sub,.psb,.txt (The subtitle file should have exactly the same name to corresponding MPEG4 file name)
- Some MPEG4 files created on a personal computer may not be able to be played back. This is why Codec Type,Version and Higher resolutions over specification are not supported.

## Playing the Title List



Follow these instructions to play back a scene from the Title List.

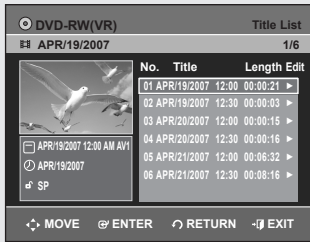

1. Press the **TITLE LIST** button. The Title List screen is displayed. You can also use the **MENU** button.
  - Press the **MENU** button.
  - Press the **▲▼** buttons to select Title List, and then press the **ENTER** or **▶** button twice.
2. Press the **▲▼** buttons to select **Title**.
  - Press the **PLAY** button. The selected entry (title) will be played back.
  - Press the **ENTER** or **▶** button. The Edit menu is displayed on the right. (**Rename, Delete, Edit, Protection** : See pages 68~70)
3. To stop playing the title, press the **STOP** (⏏) button. To return to the title list screen, press the **TITLE LIST** button.

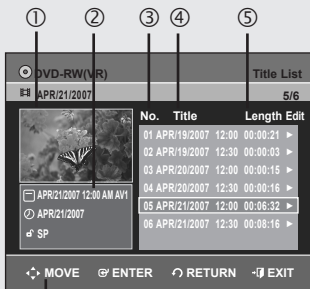

### Title List Screen Elements

- ① Playback screen for recorded entries
- ② Information window for the selected entry : Title name, recording date, lock status, record mode
- ③ Recorded entry No.
- ④ Recorded entry title
- ⑤ Recording length (i.e., the playing time)
- ⑥ Title list edit items
  - Play** : Plays the selected entry.
  - Rename** : Renames the title of a selected entry.
  - Delete** : Deletes the selected entry from the list.
  - Edit** : Deletes a section.
  - Protection** : Locks or unlocks the selected entry.
- ⑦ Button display



- By pressing the **ANYKEY** button, you can play the desired title.
- This may depend on the the disc type.
- DVD-R/DVD-RW(Video) has limited editing function.(See page 44)



# Editing

*This section introduces basic functions of DVD editing.*

## • Title List

A title is a section of recorded video and audio.

The Title List shows a list to help you select a title.

If one title is deleted from the title list, that title cannot be played again.

## • Playlist

This refers to a unit of playback, which is made by selecting a desired scene in the entire Title List.

When one playlist is played, only the scene selected by the user will play and then stop. Since only the information necessary for playing a desired scene is included in a playlist, even if that playlist is deleted, the original recorded title will not be deleted.

**Recording or editing might not be completed if an error such as a sudden power failure occurs.**

**Please be aware that material that has been damaged cannot be retrieved.**

## Basic Editing (Title List)

### Renaming (Labeling) a Title



*Follow these instructions to rename a title list entry, i.e., to edit the title of a recorded program.*

1. Press the **TITLE LIST** button. The Title List screen is displayed.  
You can also use the **MENU** button.
  - Press the **MENU** button.
  - Press the **▲▼** buttons to select Title List, and then press the **ENTER** or **▶** button twice.
2. Press the **▲▼** buttons to select an entry you want to rename from the **Title List**, and then press the **ENTER** or **▶** button.
3. Press the **▲▼** buttons to select **Rename**, and then press the **ENTER** or **▶** button.  
The Rename screen is displayed.
4. Select the desired characters using the **▲▼◀▶** buttons, press the **ENTER** button.
  - **Back Space** : Deletes the character before the cursor.
  - **Space** : Enters a blank and moves the cursor one forward (to the right).
  - **Delete** : Deletes the character at the cursor position.
  - **Clear** : Deletes all the character inputs.
  - **Save** : Registers the character inputs.
  - The maximum number of characters that can be entered is 31. All 31 characters can be displayed by pressing the **INFO** button twice.
5. Press the **▲▼◀▶** buttons to select **Save**, and then press the **ENTER** button.  
The changed title name is displayed on the title item of the selected Title list entry.



## Locking (Protecting) a Title



Follow these instructions to lock an entry to protect it from accidental deletion.

1. Press the **TITLE LIST** button. The Title List screen is displayed. You can also use the **MENU** button.
  - Press the **MENU** button.
  - Press the **▲▼** buttons to select Title List, and then press the **ENTER** or **▶** button twice.
2. Press the **▲▼** buttons to select an entry you want to protect from the **Title List**, and then press the **ENTER** or **▶** button.
3. Press the **▲▼** buttons to select **Protection**, and then press the **ENTER** or **▶** button.
4. Press the **◀▶** buttons to select **On**, and then press the **ENTER** button. The lock icon on the information window for the selected entry changes to the locked status. (🔒 → 🔒) If you want to unlock the title entry, select the protected title and set the Protection function to **Off**.

## Deleting a Title

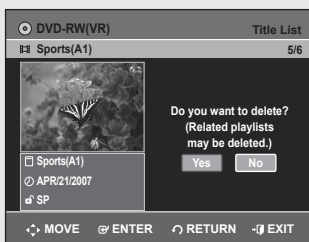

Follow these instructions to delete an entry from the Title List.

1. Press the **TITLE LIST** button. The Title List screen is displayed. You can also use the **MENU** button.
  - Press the **MENU** button.
  - Press the **▲▼** buttons to select Title List, and then press the **ENTER** or **▶** button twice.
2. Press the **▲▼** buttons to select an entry you want to delete from the Title List, and then press the **ENTER** or **▶** button.
3. Press the **▲▼** buttons to select **Delete**, and then press the **ENTER** or **▶** button. You will be prompted with the confirmation message.
 

**DVD-RAM, DVD-RW(VR mode):** Since Playlist is present, the message "Do you want to delete?(Related playlists may be deleted.)" is displayed.

**DVD-RW(Video mode), DVD-R:** Since Playlist is not present, the message "Do you want to delete?" is displayed.

  - The message may be different depending on the type of disc.
4. Press the **◀▶** buttons to select **Yes**, and then press the **ENTER** button.



- You cannot delete a protected entry. If you want to delete a protected entry, select "Off" in the Title Protection menu.
- Once an entry is deleted from the Title List, it cannot be recovered.
- Once a DVD-R or DVD-RW is finalized, it cannot be deleted.
- With DVD-R, titles are only deleted from the menu, however, the Title remains physically on the disc.

## Deleting a Section of a Title



(VR mode)

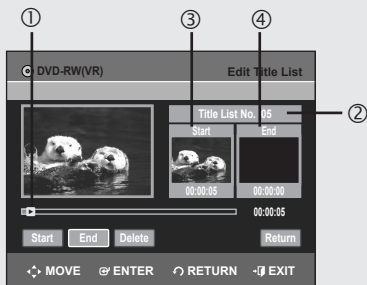

Follow these instructions to delete a section of a Title List entry.

1. Press the **TITLE LIST** button. The Title List screen is displayed. You can also use the **MENU** button.
  - Press the **MENU** button.
  - Press the **▲▼** buttons to select Title List, and then press the **ENTER** or **▶** button twice.
2. Press the **▲▼** buttons to select an entry you want to edit from the Title List, and then press the **ENTER** or **▶** button.
3. Press the **▲▼** buttons to select **Edit**, and then press the **ENTER** or **▶** button.
4. Press the **ENTER** button at the starting point. The image and starting point time are displayed on the section deletion starting point window.
5. Press the **ENTER** button at the end point. The image and end point time are displayed in the Section deletion ending point window.
6. Press the **◀▶** buttons to select **Delete**, and then press the **ENTER** button. The message "Do you want to delete?(Deleted part will not be restored)" is displayed.
7. Press **◀▶** buttons to select **Yes**, and then press the **ENTER** button. The selected section is deleted. To return to the Title List screen, press the **◀▶** buttons to select **Return**.

### ◆ Edit Title List Screen Elements

- ① Playback bar
- ② Title List No.
- ③ Section deletion starting point window and time
- ④ Section deletion end point window and time
  - Select the start and end points of the section you want to delete using the playback related buttons.
  - Playback related buttons ( **◀▶**, **◀◀**, **▶▶**, **⏮**, **⏭**, **⏪**, **⏩** ).



- The length of the section to be deleted must be at least 5 seconds long.
- If the length of the section to be deleted is less than 5 seconds, you will be prompted with the message "The range is too short."
- If the end time precedes the starting point, you will be prompted with the message "End point cannot be marked earlier than start point".
- The section cannot be deleted when it includes a still picture.

## Advanced Editing (Playlist)

### Creating a Playlist



(VR mode)

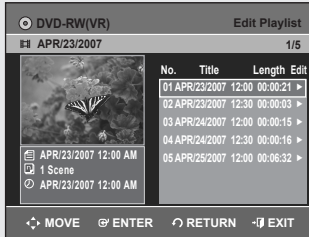
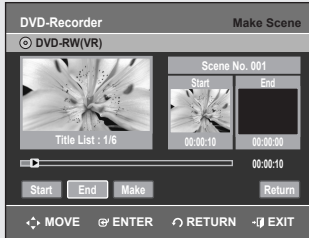

*You can use this feature to create and extract new scenes from an existing recording. Follow these instructions to create a new playlist entry from a recorded title.*

1. With the unit in Stop mode, press the **MENU** button on the remote control.
2. Press the **▲ ▼** buttons to select **Playlist**, and then press the **ENTER** or **▶** button.
3. Press the **▲ ▼** buttons to select **New Playlist**, and then press the **ENTER** or **▶** button.  
The Make Scene screen is displayed.
4. Press the **ENTER** button at the start point.
  - The image and starting point time are displayed on the Start window.
  - The yellow-colored selection bar moves to the **End** item.
  - Select the starting point of the section from which you want to create a new scene using the playback related buttons (**◀ ▶**, **⏪ ⏩**, **⏮ ⏭**, **⏰ ⏱**).
5. Press the **ENTER** button at the end point.
  - The image and end point time are displayed on the **End** window.
  - The yellow-colored selection bar moves to the **Make** item.

#### - To make a new playlist -

6. Press the **◀ ▶** buttons to select **Make**, and then press the **ENTER** button.  
A new Scene will be added to the current Playlist.  
A new Make Scene screen is displayed.  
Repeat the above steps 4~6 to create further scenes.



- If you want to make a new playlist, go to **MENU** → new playlist.
- You can check and see all the scenes on the Edit Playlist screen.

#### - To return to the Edit Playlist menu -

7. Press the **◀ ▶** buttons to select **Return**, and then press the **ENTER** button.  
The Edit Playlist screen is displayed.



- You can create up to 99 playlist entries.
- Depending on the disc type, the displayed screen may look slightly different.
- A disc that is recorded on this unit cannot be displayed playlist menu if EZ REC MODE set to 'On'.

### Playing Entries in the Playlist



(VR mode)

*Follow these instructions to play the playlist entries.*

1. With the unit in stop mode, press the **PLAYLIST** button.  
The Edit Playlist screen is displayed.
2. Press the **▲ ▼** buttons to select the title you want to edit from the Playlist, and then press the **ENTER** or **▶** button.
3. Press the **▲ ▼** buttons to select **Play**, and then select the **ENTER** button.  
The playlist entries will be played.
4. Press the **STOP** (**⏹**) button to stop playing.  
The screen returns to the Edit Playlist screen.

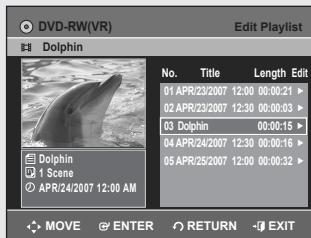
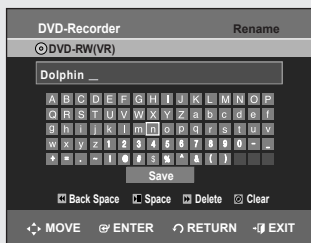

## Renaming a Playlist Entry



(VR mode)

Follow these instructions to rename a playlist entry, i.e. to edit the title of a playlist entry.

1. With the unit in stop mode, press the **PLAY LIST** button.  
The Edit Playlist screen is displayed.
2. Press the **▲▼** buttons to select the title you want to edit from the Playlist, and then press the **ENTER** or **▶** button.
3. Press the **▲▼** buttons to select **Rename**, and then press the **ENTER** button.
4. Enter the desired characters using the **▲▼◀▶** buttons.
  - **Back Space**: Deletes the character before the cursor.
  - **Space**: Enters a blank and moves the cursor one forward (to the right).
  - **Delete**: Deletes the character at the cursor position.
  - **Clear**: Deletes all the character inputs.
  - **Save**: Registers the character inputs.
    - The maximum number of characters that can be entered is 31. All 31 characters can be displayed by pressing the **INFO** button twice.
5. Press the **▲▼◀▶** buttons to select **Save**, and then press the **ENTER** button.  
The changed title name is displayed on the title item of the selected playlist entry.

## Editing a Scene for the Playlist

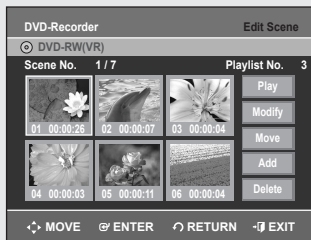

(VR mode)

Follow these instructions to edit scenes for a playlist

1. With the unit in stop mode, press the **PLAY LIST** button.  
The Edit Playlist screen is displayed.
2. Press the **▲▼** buttons to select the title you want to edit from the Playlist, and then press the **ENTER** or **▶** button.
3. Press the **▲▼** buttons to select **Edit Scene**, and then press the **ENTER** button.  
The Edit Scene screen is displayed.

## Playing a Selected Scene

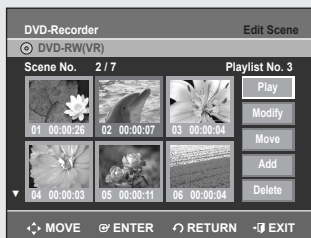

4. Press the **▲▼◀▶** buttons to select the scene you want to play, and then press the **ENTER** button.  
The playlist entry to be played is selected.
5. Press the **ENTER** button.  
The selected scene is played.
  - To stop scene play, press the **STOP** (⏻) button.



## Modifying a Scene (Replacing a Scene)

Follow steps 1 to 3 of *Editing a Scene for the Playlist* on page 72.

4. Press the ▲▼◀▶ buttons to select the scene you want to modify, and then press the **ENTER** button.
5. Press the ▲▼ buttons to select **Modify**, and then press the **ENTER** button.
6. Press the **ENTER** button at the start point of the scene.
  - The image and starting point time are displayed on the Start window.
  - Select the starting or ending point of the section you want to modify using the playback related buttons (◀, ⏪, ⏩, ▶, ⏮, ⏭, ⏯, ▶).
7. Press the **ENTER** button at the end point of the scene.
  - The image and ending point time are displayed on the End window.
8. Press the ◀▶ buttons to select **Change**, and then press the **ENTER** button.
  - The scene you want to modify is changed with the selected section.

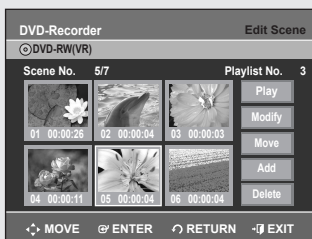
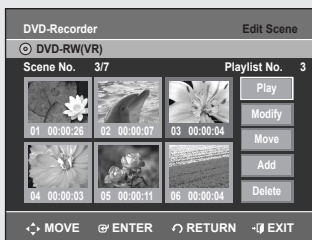
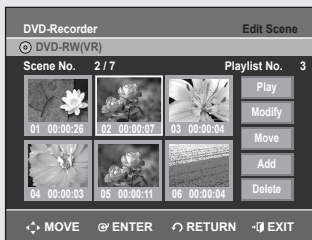
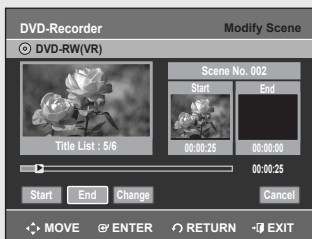
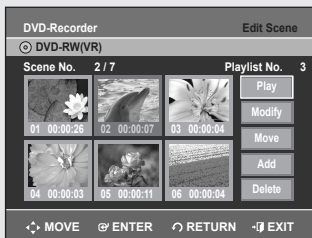

## Moving a Scene (Changing the Position of a Scene)

Follow steps 1 to 3 of *Editing a Scene for the Playlist* on page 72.

4. Press the ▲▼◀▶ buttons to select the scene you want to move (change the position), and then press the **ENTER** button.
5. Press the ▲▼ buttons to select **Move**, then press the **ENTER** button.
  - A yellow selection window is displayed on the scene to be moved.
6. Press the ▲▼◀▶ buttons to select the position to which you want to move the selected scene, and then select the **ENTER** button.
  - The selected scene is moved to the selected position.



- Depending on the disc type, the displayed screen may look slightly different.

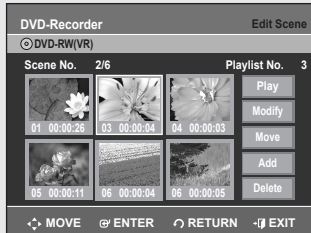
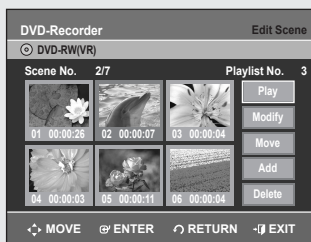
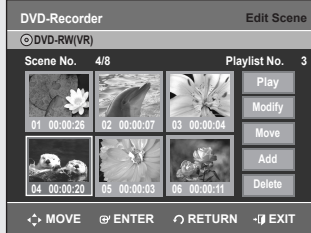
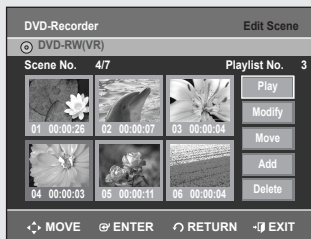

## Adding a Scene

Follow steps 1 to 3 of *Editing a Scene for the Playlist* on page 72.

- Press the **▲▼◀▶** buttons to select the scene that will have a new scene inserted before it, and then press the **ENTER** button.  
A yellow selection window is displayed on the scene to be added as the new scene.
- Press the **▲▼** buttons to select **Add**, then press the **ENTER** button.
- Press the **ENTER** button at the starting point of the scene.
  - The image and starting point time are displayed on the **Start** window.
  - Select the end point of the section where you want to add the new scene using the playback related buttons (**◀▶**, **⏪**, **⏩**, **⏮**, **⏭**, **⏯**, **⏰**).
- Press the **ENTER** button at the end point of the scene.
  - The image and end point time are displayed in the **End** window.
  - To cancel, press the **◀▶** buttons to select **Cancel** and then press the **ENTER** button.
- Press the **◀▶** buttons to select **Add**, and then press the **ENTER** button.
  - The section you want to add is inserted prior to the scene selected in step 4.

## Deleting a Scene

Follow steps 1 to 3 of *Editing a Scene for the Playlist* on page 72.

- Press the **▲▼◀▶** buttons to select the scene you want to delete, and then press the **ENTER** button.
- Press the **▲▼** buttons to select **Delete**, and then press the **ENTER** button.

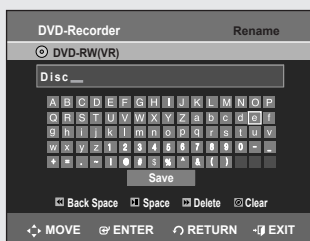
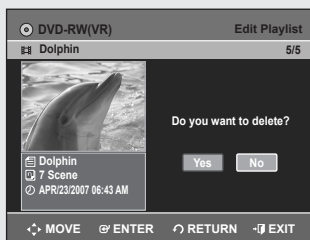
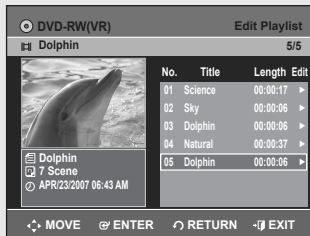
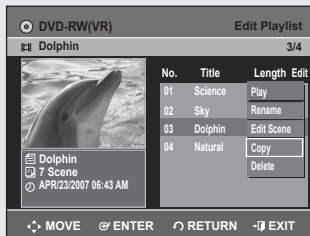

## Copying a Playlist Entry to the Playlist

1. Press the **PLAY LIST** button.  
The Edit Playlist screen is displayed.
2. Press the **▲ ▼** buttons to select the title you want to copy to the Playlist, and then press the **ENTER** or **▶** button.
3. Press the **▲ ▼** buttons to select **Copy**, and then press the **ENTER** button.  
Playlist that has been selected will be copied.

■ The playlist can contain up to 99 playlist entries (titles).

## Deleting a Playlist Entry from the Playlist

1. With the unit in Stop mode, press the **PLAY LIST** button.  
The Edit Playlist screen is displayed.
2. Press the **▲ ▼** buttons to select the title you want to edit from the Playlist, and then press the **ENTER** or **▶** button.
3. Press the **▲ ▼** buttons to select **Delete**, and then press the **ENTER** button.
4. Press the **◀ ▶** buttons to select **Yes**, and then press the **ENTER** button.  
You are automatically returned to the Edit Playlist screen after the deletion operation has finished.

## Disc Manager

### Editing the Disc Name



*Follow these instructions to give a name to a disc.*

1. With the unit in Stop mode, press the **MENU** button on the remote control.
2. Press the **▲ ▼** buttons to select **Disc Manager**, then press the **ENTER** or **▶** button.
3. Press the **▲ ▼** buttons to select **Disc Name**, then press the **ENTER** or **▶** button.  
The Rename screen is displayed.
4. Enter the desired characters using the **▲ ▼ ◀ ▶** buttons.
  - **Back Space** : Deletes the character before the cursor.
  - **Space** : Enters a blank and moves the cursor one forward (to the right).
  - **Delete** : Deletes the character at the cursor position.
  - **Clear** : Deletes all the character inputs.
  - **Save** : Registers the character inputs.
  - The maximum number of characters that can be entered is 31. All 31 characters can be displayed by pressing the **INFO** button twice.
5. Press the **▲ ▼ ◀ ▶** buttons to select **Save**, and then press the **ENTER** button.  
A disc name is given to the disc.

■ You may need to disable disc protection before beginning editing. (see page 76.)

■ Depending on the kind of disc, the displayed screen may be different.

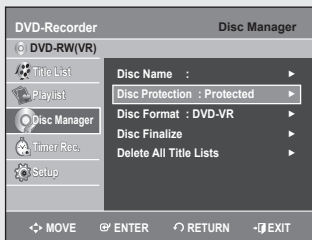

## Disc Protection



**Disc Protection allows you to protect your discs from being formatted or deleted due to unintended operations**

1. With the unit in Stop mode, press the **MENU** button on the remote control.
2. Press the **▲▼** buttons to select **Disc Manager**, and then press the **ENTER** or **▶** button.
3. Press the **▲▼** buttons to select **Disc Protection**, then press the **ENTER** or **▶** button.
4. Press the **▲▼** buttons to select **Protected**, then press the **ENTER** button.

## Formatting a Disc



**DVD-RAM/DVD-RW discs must be prepared (formatted) before they can be recorded on.**

**Use these instructions to format a disc. Disable disc protection before formatting.**

1. With the unit in Stop mode, press the **MENU** button on the remote control.
2. Press the **▲▼** buttons to select **Disc Manager**, and then press the **ENTER** or **▶** button.
3. Press the **▲▼** buttons to select **Disc Format**, and then press the **ENTER** or **▶** button.

### DVD-RAM

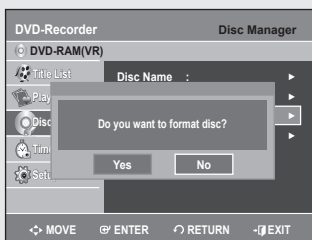

### DVD-RAM

- You will be prompted with the confirmation message "Do you want to format disc?".
- If you select **Yes** using the **◀▶** buttons and press the **ENTER** button, you will be prompted with the confirmation message "All data will be deleted. Do you want to continue?".

### DVD-RW

- You will be prompted with the confirmation message "Choose the recording format for DVD-RW"
4. Press the **◀▶** buttons to select desired mode, then press the **ENTER** button.
    - You will be prompted again with the message "All data will be deleted. Do you want to continue?"
  5. Press the **◀▶** buttons to select **Yes**, and then press the **ENTER** button. The disc is formatted.

### DVD-RW

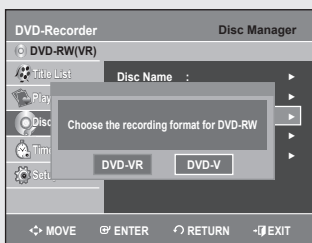

DVD-VR and DVD-V modes are compatible with the following disc types.

DISC	DVD-VR	DVD-V
	DVD-RAM	DVD-RW
	DVD-RW	DVD-R

- Menu items may differ depending on the disc type.
- Discs need to be formatted in the following cases:
  - The first time you use a new DVD-RAM/-RW Disc
  - You want to change the VR or V mode of a DVD-RW disc.

## Finalizing a Disc



*After you record titles onto a DVD-RW/DVD-R disc with your DVD recorder, it needs to be finalized before it can be played back on external devices such as a DVD player.*

1. With the unit in Stop mode, press the **MENU** button on the remote control.
2. Press the **▲▼** buttons to select **Disc Manager**, and then press the **ENTER** or **▶** button.
3. Press the **▲▼** buttons to select **Disc Finalize**, and then press the **ENTER** or **▶** button.  
You will be prompted with the message "Do you want to finalize disc?".
4. Press the **◀▶** buttons to select **Yes**, then press the **ENTER** button.  
You will be prompted again with the message "Disc will be finalized. Do you want to continue?".
5. Press the **◀▶** buttons to select **Yes**, and then press the **ENTER** button.  
The disc is finalized.



- Once a disc is finalized, you cannot delete entries from the record list.
- Once a DVD-R/DVD-RW (video mode) disc is finalized, it is playable in a standard DVD player.
- Depending on disc type, the displayed screen may appear slightly different.
- Finalizing time may be different depending on the amount of data recorded on the disc.
- Data on the disc will be damaged if the recorder is powered off during finalizing process.
- You can finalize automatically using EZ REC MODE. (See page 54)

## Unfinalizing a Disc (V/VR mode)



1. With the unit in Stop mode, press the **MENU** button on the remote control.
2. Press the **▲▼** buttons to select **Disc Manager**, and then press the **ENTER** or **▶** button.
3. Press the **▲▼** button to select **Disc Unfinalize**, and then press the **ENTER** or **▶** button.  
You will be prompted with the message "Do you want to unfinalize disc?".
4. Press the **◀▶** buttons to select **Yes**, then press the **ENTER** button.  
You will be prompted again with the message "Disc will be unfinalized. Do you want to continue?".
5. Press the **◀▶** buttons to select **Yes**, and then press the **ENTER** button.  
The disc is unfinalized.



- A DVD-RW can be finalized or unfinalized in Video mode.

	Finalize	Unfinalize
Mark	DVD-Video(RW)	DVD-RW(V)
Operation	Same as DVD-Video	Additional recording, protection and deletion are possible.

- A DVD-RW can be finalized or unfinalized in VR mode.

	Finalize	Unfinalize
Mark	DVD-RW(VR:F)	DVD-RW(VR)
Operation	Additional recording, deletion, editing, and protection are impossible.	Additional recording, deletion, editing, and protection are possible.

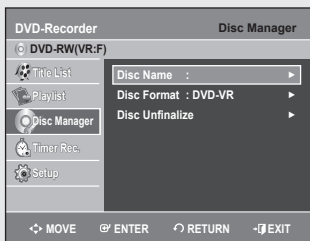



## Delete All Title Lists



*The disc protection should be disabled first.*

1. With the unit in Stop mode, press the **MENU** button on the remote control.
2. Press the **▲▼** buttons to select **Disc Manager**, and then press the **ENTER** or **▶** button.
3. Press the **▲▼** buttons to select **Delete All Title Lists**, and then press the **ENTER** or **▶** button.
  - When Protected Entry exists: The Delete All Title List function will not operate. If you want to delete a protected title, disable Protection for it on the Lock item. (See page 69)
4. Press the **◀▶** buttons to select **Yes**, and then press the **ENTER** button. All title lists are deleted.



# Additional Information

## Troubleshooting

*If your product malfunctions, go through the checkpoints below before contacting a Samsung authorized service center.*

### Power

*The input is displayed for a while when the power is turned on.*

- Checkpoint 1** The DVD recorder requires some time to initialize and the input will be displayed for approx. 10 seconds after it is turned on.

### Recording

*Cannot record TV programs.*

- Checkpoint 1** Check whether the power cord is securely plugged into the power outlet.
- Checkpoint 2** Check the free space on your DVD-RAM/DVD-RW/DVD-R discs.

*I pressed the REC button but there is no response.*

- Checkpoint 1** Recording is possible for DVD-RAM/DVD-RW/DVD-R discs only. If a program is copy protected, it cannot be recorded.

### Playback

*Cannot play the disc.*

- Checkpoint 1** Check whether the disc is inserted correctly with the label facing up.
- Checkpoint 2** Check the regional code of the DVD disc.
- Checkpoint 3** This DVD recorder cannot play some types of discs. (See pages 5, 56)

*⊗ icon appears on the screen.*

- Checkpoint 1** You cannot use this operation or function due to one of the following reasons:
  - (1) Your DVD disc restricts it.
  - (2) Your DVD disc does not support this feature (for example: angles)
  - (3) The feature is not available at the moment.
  - (4) You've requested a title, chapter, or scan time that is out of range.

*Play mode settings are different from the settings configured in the Settings menu.*

- Checkpoint 1** The disc does not support all selected functions. In this case, some settings configured in the settings menu may not work properly.

*Cannot change the aspect ratio.*

- Checkpoint 1** The aspect ratio is fixed for DVD discs. (See page 39)

*The angle operation does not work while playing a DVD disc.*

- Checkpoint 1** The angle operation is available only when the disc contains images captured from different angles.

*The selected audio and/or subtitle language is not played.*

- Checkpoint 1** Audio and subtitle languages are disc specific. Only the sound and subtitle languages contained on the DVD disc are available and displayed in the disc menu.

### Video

*The disc revolves, but no image or bad quality images are displayed.*

- Checkpoint 1** Check whether there is damage to or any foreign material on your disc.
- Checkpoint 2** Some low quality discs may not play properly.
- Checkpoint 3** If scenes change from dark to bright suddenly, the screen may shake vertically temporarily, but this is not a default of the unit.

## Sound

### No sound.

- Checkpoint 1** Are you watching a program in scan mode?  
If you are playing a program at a speed other than normal and fast1 speed, the sound will not be heard.
- Checkpoint 2** Check the connections and settings.
- Checkpoint 3** Check whether the disc is damaged. Clean the disc, if necessary.
- Checkpoint 4** Check whether the disc is inserted correctly with the label facing up.

### No audio output.

- Checkpoint 1** Check whether you have selected the correct digital output options in the Audio Output Options menu. (See page 38)

## Timer Recording

### Timer lamp flickers.

- Checkpoint 1** Check if there is enough space in the disc for recording.
- Checkpoint 2** Check whether the current disc is recordable or not. Make sure to check before the start time of recording.

### Timer recording does not work properly.

- Checkpoint 1** Re-check the recording time and the end time settings again.
- Checkpoint 2** Recording will be cancelled, if the power is disconnected due to a power failure or other similar reason, while recording.

## HDMI

### No HDMI output.

- Checkpoint 1** Check to see that the Video output is HDMI enabled.
- Checkpoint 2** Check the connection between the TV and the HDMI jack of the DVD Recorder.
- Checkpoint 3** See if your TV supports 480p/720p/1080i resolution.

### Abnormal HDMI output screen.

- Checkpoint 1** If snow noise appears on the screen, it means that the TV does not support HDCP (High-bandwidth Digital Content Protection).  
If connected via DVI, try turning the DVD Recorder off then On.

### HDMI output Jitter

- Checkpoint 1** Check your TV system setup correctly.
- Checkpoint 2** Screen Jitter may occur when the frame rate is converted from 50Hz to 60Hz for 720p/1080i HDMI (High Definition Multimedia Interface) Output.
- Checkpoint 3** Please refer to the user's manual of your TV.

## Remote Control Unit

### The remote control doesn't work.

- Checkpoint 1** Point the remote control at the remote control sensor on your DVD recorder. Allow for proper distance. Remove obstacles between your DVD recorder and the remote control.
- Checkpoint 2** Check whether the batteries are empty.

## Other

### I forgot my password for parental supervision.

- Checkpoint 1** Remove the disc. Press the **CH** ( $\wedge$  /  $\vee$ ) buttons on the front panel of the DVD Recorder simultaneously for 5 seconds or more when the power is on. All settings including the password will revert to the factory settings. Do not use this unless absolutely necessary. (Note that this function is possible only when no disc is inserted.)

### Is it possible to change a subtitle and an audio signal on a recorded disc?

- Checkpoint 1** A recorded disc is played with only the subtitle and the audio signal which were selected during recording.

### Other problems.

- Checkpoint 1** Read the table of contents and then find and read the section describing your problem, and follow the instructions given.
- Checkpoint 2** Turn your DVD recorder off and on.
- Checkpoint 3** If the problem still persists, contact a nearby Samsung service center.



# Cable Box/Satellite Receiver Brand Code Table

## Cable box brand

Cable box brand	Code number
3M	0033
ABC	0003, 0011, 0017, 0008, 0014,
Accuphase	0007, 0001, 0013, 0206, 0047, 0237, 0033 0003, 0013, 0047, 0001, 0011,
Acorn	0017, 0014, 0206, 0007 1102, 0237
Action	0237
Active	0237, 1102
Aim	0015
Allegro	0315, 0153
Amark	0008, 0277, 0144, 0056
American	0060
Americast	0899
Antronix	0207, 0022
Anvision	0211, 0111
Apache	0770
Arbatron	0014, 0011, 0003, 0476
Archer	0153, 0022, 0207, 0039, 0797,
ASE	0237, 0260 1080
Auna	1269
BBT	0267
BCC	0276
Belcor	0056, 0022
Bell & Howell	0014
Bell Atlantic	0641
Bell South	0899
Bestlink	0303
Betavue	0022
British Telecom	0003
BVS	0641
Cable Healthcare	0769, 0058
Cable Star	0056
Cabletenna	0022, 0039
Cableview	0022
Century	0153, 0618, 0008, 0315
Citation	0017
Citizen	0153, 0315, 0078, 0242
Clearmaster	0883
ClearMax	0883, 1247
Colour Voice	0031, 0025
Combant	0233, 0232
Comtec	0274
Comtronics	0060, 0040
Comtronics Eagle	0040, 0060
Contec	0019
Coolmax	0883
Curtis Mathes	0015, 0242
Dae Ryung Eagle	0008
Dae Ryung	0008, 0877, 0477, 0277, 1877
Diamond	0035
Digeo	1476, 1897
Digi	0637
Director	0476
Dumont	0637
Eagle Comtronics	0060, 0028

Cable box brand	Code number
Eastern	0002, 0274, 0418
Electricord	0078
Emerson	0797, 0303, 0015, 0014
Everquest	0040, 0015
Focus	0400
Fosgate	0276
Fujitsu	0246
Funai	0248, 0019
FutureVision	0649
Garrard	0153
Gateway	0764
GC Electronics	0207, 0056, 0330, 0016, 0040, 0077, 0030
GE	0232, 0233, 0144, 0021
Gemini	0015, 0070, 0057, 0242, 0014, 0797, 0013, 0400
General Instrument	0476, 0011, 0014, 0098, 0810, 0024, 0003, 0015, 0276, 1376, 1476
GHZ	0078
Gibraltar	0003
Global	1327
GMI	0069, 0057, 0015, 0797
Goldstar	0144, 0040
Goodmind	0770, 0797
Gradiente	1136
Hamiln	0020, 0009, 0034, 0259, 0015, 0273, 0206
Healthway Interactive	0058, 1020, 1015, 0769
Hitachi	0011, 0154, 0009, 0008, 0003, 0033, 0014, 0255
Houston Tracker	0011
Hwalin	0303
Hytex	0007
IBM	0670
IEEC	1018
Interbuy	0274
Jasco	0315, 0153, 0015
Jebsee	0014, 0400
Jerrold	0003, 0014, 0276, 0011, 0012, 0020, 0024, 0015, 0047, 0098, 0476, 0031, 0029, 0111, 0032, 0054, 0810, 0028
Kuang Yu	0024
Leon	0069, 0015
LG	0040, 0144
Linsay	0440
Macom	0033
Maestro	0812
Magnavox	0797, 0027, 0032, 0334, 0069
Millennium	0618, 0153
Memorex	0000
Mitsubishi	0003
Motorola	0476, 0276, 1476, 0810, 1376, 1254, 0400, 1106
Movie Time	0156, 0078, 0063, 0203
MS	0069, 0015, 1018, 0303
MultiVision	0012
Myrio	1117
NET	0274
Next Level	0764, 1316, 1315, 1314

Cable box brand	Code number
Nexus	0770
Northcoast	0671, 0314
Nova Vision	0277, 0008
Novabeam	0277
Novaplex	0618, 0277, 0017, 0008
NSC	0156, 0070, 0203, 0063, 0400, 0012, 0618, 0022, 0637, 0010, 0044
Oak	0019, 0007, 0303, 0248, 0017
Omega	0015
Omniview	0371
Optimus	0021
Pace	0008,0237,0277,0477,0877, 1877,0810,1376,1476
Pacific Bell	0843
Panasonic	0107, 0021, 0144, 0008, 0124, 0307, 0000, 0040
Panther	0637
Paragon	0000, 0525, 0008
Penney	0637, 0000
Philips	0025, 0031, 0290, 0027, 0030, 0153, 0060, 0242, 0028, 0334, 0211, 0029, 0259,0307, 0652, 0013, 0069, 0649, 0255, 0305, 0032, 0111, 0317
Pioneer	0144, 0023, 0533, 1877, 0877, 0260, 0008, 0277, 0477
Popular Mechanics	0400
Prelude	0770
Prism	0012, 0013, 0059
Protelcon	0786
Pulsar	0000, 0040
Quasar	0000
Quest	0144, 0020
R Line	0040
RadioShack	0883, 0015, 0315, 0303, 0797
Rampage	0255
Ranger	1247
RCA	0021, 0060, 0797,0047, 1256, 0843
Realistic	0207, 0153
Recoton	0153, 0400
Regal	0259, 0020, 0273, 0279, 0276
Regency	0002, 0020, 0682
Rembrandt	0070, 0153, 0040, 0022, 0011
RK	0304, 0479
Runco	0000
Samsung	0040, 0144, 0023, 0003, 0070, 0000, 1898
Sasktel	1737
Scientific Atlanta	0008, 0277, 0017, 0006, 0237, 0025, 0477, 0207, 0877, 0003, 0012, 0000, 0021, 1877
Seam	0510
Sears	0510
Sejin	1265
Siemens	0246
Sigma	0019
Signal	0040, 0015, 0011, 0035
Signature	0011
SkyCable	0112
Skygiant	1091
SL Marx	0040
Sony	1006, 1506, 1606
Spectradyne	0769, 0058
Spectravision	0058
Sprucer	0021, 0307, 0010, 0144

Cable box brand	Code number
Standard Components	0203, 0096, 0155
Starcom	0003, 0015, 0047, 0014, 0098, 0305
Stargate	0015, 0040, 0770, 0865, 0797, 0305, 0014
Starquest	0015
StarSight	0542, 0422
Stealth	0274
Stellar One	0807
Storm	1018, 0637
Suena Madritel	1230
Supercable	0276
Supermax	0883
Sylvania	0001
Tandy	0258
Tatung	0097
Teac	1018
Technics	0029
Teknika	0146
Teleavia	0040
TeleCaption	0221
Television	0063, 0040
Texscan	0001, 0096, 0010
TFC	0310
Thomson	1256
Timeless	0418, 0274, 0040
Tocom	0012, 0013, 0029, 0019, 0059, 0017
Torx	0003
Toshiba	0000
Trans PX	0303, 0276, 0153, 0315
Trinity	1248
Tristar	0883
TS	0255, 0024, 1018, 0003, 0303
Tusa	Tusa
TV COMM	0035, 0019
TV Guide	1476
TV86	0063, 0040
Uniden	0225, 0022
Unika	0207, 0153, 0022
United Artists	0007
United Cable	0003, 0014, 0011, 0276
Universal	0191, 0078, 0207, 0056, 0022, 0039, 0153, 0077, 0322, 0315
US Electronics	0276, 0008, 0003, 0017
V2	0883
Verizon	0246
Video way	0250, 0000
Video Works	0124
Vidtech	0244
Viewmaster	0883, 0770
Viewstar	0258, 0289, 0060, 0063, 0211, 0618, 01530027, 0111, 0030, 0121
Vision	0883
Visionetics	1264
Vortex View	0883
WaveMaster	0565
Wiso	0078
Zenith	0000, 0525, 0054, 0017, 0039, 0153, 0060, 0315, 0191, 0899
Zenitek	0400

## Satellite receiver brand

Satellite receiver brand	Code number
AlphaStar	0772
Atlantic Telephone	1333
Bell ExpressVu	0775
Century	0856
Chaparral	0216
Crossdigital	1109
DirecTV	1887, 0749, 0566, 0392, 1749, 0099, 1109, 1076, 1442, 1856, 0247, 1142, 1639, 0724, 0639,
Dish Network System	0775, 1005, 1170
Dishpro	0775, 1005
Echostar	0775, 1170, 1005
Expressvu	0775
Galaxis	0863
GE	0566
General Instrument	0361, 0869, 0627
GOI	0775
Gradiente	0856
Hitachi	0819, 0749
Houston Tracker	0775
HTS	0775
Hughes Network Systems	0749, 1749, 1442, 1142
Humax	1176, 1359, 1048, 0863, 0283
Innova	0099
Jerrold	0361, 0036, 0627
JVC	0775, 1170
Magnavox	0722, 0724
McIntosh	0869
Memorex	0724
Mitsubishi	0749
Motorola	0869
NEC	1270, 0496, 0499, 0507, 0508
Netsat	0099
Next Level	0869
Optimus	0724
Panasonic	0247, 0701
Paysat	0724
Philips	1076, 1142, 0724, 0722, 0749, 1442, 1749, 0856, 0775, 0099
Primestar	0361, 0627, 0869
Proscan	0392, 0566
QNS	1367
RadioShack	0869
RadioShack	0566, 0392, 0143, 0855
Samsung	1109, 1276
Sky	0856, 0099, 1856
Sony	0639, 1639
Star Choice	0869
Star Trak	0869, 0772
Thomson	0566, 0392
Tivo	1142, 1442
Toshiba	0790, 0749, 1749, 1285
UEC	1333, 1358
Uniden	0724, 0722
Video Cipher II Plus	0361
Zenith	0856, 1856

## Error Message Solutions

Before contacting a Samsung authorized service center, perform the following simple checks.

Error Message	Solution / Explanation
You cannot record a copy protected movie.	◆ You can't record the video since it is protected by copyright.
You cannot record. This disc is protected.	◆ The disc you are using is protected. To record on this disc or use this function, disable the disc protection function. Refer to page 76.
This disc cannot be formatted (the disc is protected).	
This disc cannot be renamed (the disc is protected).	
The disc cannot be finalized (the disc is protected).	
This [Menu] is not available (the disc is protected).	
The disc cannot be played, Please check the regional code of the disc.	◆ The disc does not match the regional code for your area and cannot be played on this device.
This disc cannot be formatted. Please check the disc.	◆ Make sure there are no scratches or dirt on the disc.
You could not format the disc because of error detection.	
You could not finalize the disc because of error detection.	
You could not unfinalize the disc because of error detection.	
The disc cannot be played, Please check the TV system.	◆ PAL format discs cannot be played on this unit.
The disc can be neither played nor recorded.	◆ Make sure there are no scratches or dirt on the disc.
The disc cannot be played, Please check the disc.	
If the disc has invalid information, no more titles can be recorded. Please format the disc beforehand.	◆ You can't use the disc because it contains errors from previous recordings. Use the disc after formatting.

## Error Message Solutions

Error Message	Solution / Explanation
Error is detected on the disc.	<ul style="list-style-type: none"> <li>◆ You can't use the disc because it contains errors from previous recordings. Use the disc after formatting.</li> </ul>
System error is found. Please try it again after turning off the power.	<ul style="list-style-type: none"> <li>◆ When operating, errors happen. Turn off the device. (To turn off, press and hold the power button on the front of the device for 10 seconds.) After turning off, press the Open button and remove the disc from the device.</li> </ul>
The DV device is not connected.	<ul style="list-style-type: none"> <li>◆ Make sure the DV device is connected properly to the DV connection Jack. If it is connected properly, turn it off and on once again.</li> </ul>

If you are unable to solve the problem after reading the above instructions, note:

- ◆ The model and serial number on the rear of your DVD Recorder
- ◆ The warranty information
- ◆ A clear description of the problem

Then contact your nearest SAMSUNG authorized service center. Call 1-800-SAMSUNG for a center near you.

## Specifications

General	Power requirements	120V AC, 60Hz
	Power consumption	28 Watts
	Weight	7.12lb
	Dimensions	16.9 in(W) x 12in(D) x 2.3in(H)
	Operating temp.	+41°F to +95°F
	Other conditions	Keep level when operating. Less than 75% operating humidity
Input	Broadcasting standard	NTSC, ATSC
	Band coverage	Air 2 ~ 69, Cable 1 ~ 135
	Video (1,2)	1.0 V p-p at 75Ω load, sync negative
		S-Video input (Y: 1.0Vp-p, C: 0.286Vp-p at 75Ω load)
	Audio(1,2)	Max.Audio Input Level : 2Vrms
	DV Input	IEEE 1394(4p) compatible jack
Output	Audio	Analog output jacks 1, 2
		Optical/Coaxial digital audio output
		Full scale Analog output level : 2Vrms
	Video	Video output jack
		S-Video output (Y:1.0Vp-p, C:0.286Vp-p at 75Ω load)
		Component output (Y: 1.0Vp-p, Pb: 0.70Vp-p, Pr: 0.70Vp-p at 75Ω load)
HDMI output (480p, 720p, 1080i)		
Recording	Picture Compression format	MPEG-II
	Audio Compression format	Dolby Digital 2ch/256kbps
	Recording Quality	XP (about 8 Mbps), SP (about 4 Mbps), LP (about 2 Mbps), EP (about 1.2 Mbps or about 0.8 Mbps)
	Audio Frequency Response	20 Hz ~ 20 kHz

For DVD discs, audio signals recorded at 96kHz sampling frequency are converted and output at 48kHz.

### Audio Output

Disc Type	DVD	AUDIO CD(CDDA)
Analog Audio Output	48 / 96kHz	44.1kHz
Digital Audio Output	48kHz	44.1kHz

# Warranty

## LIMITED WARRANTY TO ORIGINAL PURCHASER

This SAMSUNG brand product, as supplied and distributed by Samsung Electronics America, Inc. (SAMSUNG) and delivered new, in the original carton to the original consumer purchaser, is warranted by SAMSUNG against manufacturing defects in materials and workmanship for a limited warranty period of:

**One (1) Year Parts / Ninety (90) days Labor  
(90 days Parts and Labor for Commercial Use)**

This limited warranty begins on the original date of purchase, and is valid only on products purchased and used in the United States. To receive warranty service, the purchaser must contact SAMSUNG for problem determination and service procedures. Warranty service can only be performed by a SAMSUNG authorized service center. The original dated bill of sale must be presented upon request as proof of purchase to SAMSUNG or SAMSUNG's authorized service center. Transportation of the product to and from the service center is the responsibility of the purchaser.

SAMSUNG will repair or replace this product, at our option and at no charge as stipulated herein, with new or reconditioned parts or products if found to be defective during the limited warranty period specified above. All replaced parts and products become the property of SAMSUNG and must be returned to SAMSUNG. Replacement parts and products assume the remaining original warranty, or ninety (90) days, whichever is longer.

SAMSUNG's obligations with respect to software products distributed by SAMSUNG under the SAMSUNG brand name are set forth in the applicable end user license agreement. Non-SAMSUNG hardware and software products, if provided, are on an "AS IS" basis. Non-SAMSUNG manufacturers, suppliers, publishers, and service providers may provide their own warranties.

This limited warranty covers manufacturing defects in materials and workmanship encountered in normal, and except to the extent otherwise expressly provided for in this statement, noncommercial use of this product, and shall not apply to the following, including, but not limited to: damage which occurs in shipment; delivery and installation; applications and uses for which this product was not intended; altered product or serial numbers; cosmetic damage or exterior finish; accidents, abuse, neglect, fire, water, lightning or other acts of nature; use of products, equipment, systems, utilities, services, parts, supplies, accessories, applications, installations, repairs, external wiring or connectors not supplied and authorized by SAMSUNG, or which damage this product or result in service problems; incorrect electrical line voltage, fluctuations and surges; customer adjustments and failure to follow operating instructions, cleaning, maintenance and environmental instructions that are covered and prescribed in the instruction book; product removal or reinstallation; reception problems and distortion related to noise, echo, interference or other signal transmission and delivery problems. SAMSUNG does not warrant uninterrupted or error-free operation of the product.

THERE ARE NO EXPRESS WARRANTIES OTHER THAN THOSE LISTED AND DESCRIBED ABOVE, AND NO WARRANTIES WHETHER EXPRESS OR IMPLIED, INCLUDING, BUT NOT LIMITED TO, ANY IMPLIED WARRANTIES OF MERCHANTABILITY OR FITNESS FOR A PARTICULAR PURPOSE, SHALL APPLY AFTER THE EXPRESS WARRANTY PERIODS STATED ABOVE, AND NO OTHER EXPRESS WARRANTY OR GUARANTY GIVEN BY ANY PERSON, FIRM OR CORPORATION WITH RESPECT TO THIS PRODUCT SHALL BE BINDING ON SAMSUNG. SAMSUNG SHALL NOT BE LIABLE FOR LOSS OF REVENUE OR PROFITS, FAILURE TO REALIZE SAVINGS OR OTHER BENEFITS, OR ANY OTHER SPECIAL, INCIDENTAL OR CONSEQUENTIAL DAMAGES CAUSED BY THE USE, MISUSE OR INABILITY TO USE THIS PRODUCT, REGARDLESS OF THE LEGAL THEORY ON WHICH THE CLAIM IS BASED, AND EVEN IF SAMSUNG HAS BEEN ADVISED OF THE POSSIBILITY OF SUCH DAMAGES. NOR SHALL RECOVERY OF ANY KIND AGAINST SAMSUNG BE GREATER IN AMOUNT THAN THE PURCHASE PRICE OF THE PRODUCT SOLD BY SAMSUNG AND CAUSING THE ALLEGED DAMAGE. WITHOUT LIMITING THE FOREGOING, PURCHASER ASSUMES ALL RISK AND LIABILITY FOR LOSS, DAMAGE OR INJURY TO PURCHASER AND PURCHASER'S PROPERTY AND TO OTHERS AND THEIR PROPERTY ARISING OUT OF THE USE, MISUSE OR INABILITY TO USE THIS PRODUCT SOLD BY SAMSUNG NOT CAUSED DIRECTLY BY THE NEGLIGENCE OF SAMSUNG. THIS LIMITED WARRANTY SHALL NOT EXTEND TO ANYONE OTHER THAN THE ORIGINAL PURCHASER OF THIS PRODUCT, IS NONTRANSFERABLE AND STATES YOUR EXCLUSIVE REMEDY.

Some states do not allow limitations on how long an implied warranty lasts, or the exclusion or limitation of incidental or consequential damages, so the above limitations or exclusions may not apply to you. This warranty gives you specific legal rights, and you may also have other rights which vary from state to state.

To obtain warranty hardware service, please contact SAMSUNG at:

Samsung Electronics America, Inc.  
105 Challenger Road Ridgefield Park, NJ 07660-0511  
**1-800-SAMSUNG (726-7864) and [www.samsung.com](http://www.samsung.com)**

## Contact SAMSUNG WORLD WIDE

If you have any questions or comments relating to Samsung products, please contact the SAMSUNG customer care center.

Region	Country	Customer Care Center	Web Site
North America	CANADA	1-800-SAMSUNG (7267864)	<a href="http://www.samsung.com/ca">www.samsung.com/ca</a>
	MEXICO	01-800-SAMSUNG (7267864)	<a href="http://www.samsung.com/mx">www.samsung.com/mx</a>
	U.S.A	1-800-SAMSUNG (7267864)	<a href="http://www.samsung.com">www.samsung.com</a>
Latin America	ARGENTINE	0800-333-3733	<a href="http://www.samsung.com/ar">www.samsung.com/ar</a>
	BRAZIL	0800-124-421 4004-0000	<a href="http://www.samsung.com/br">www.samsung.com/br</a>
	CHILE	800-726-7864 (SAMSUNG)	<a href="http://www.samsung.com/cl">www.samsung.com/cl</a>
	COSTA RICA	0-800-507-7267	<a href="http://www.samsung.com/latin">www.samsung.com/latin</a>
	ECUADOR	1-800-10-7267	<a href="http://www.samsung.com/latin">www.samsung.com/latin</a>
	EL SALVADOR	800-6225	<a href="http://www.samsung.com/latin">www.samsung.com/latin</a>
	GUATEMALA	1-800-299-0013	<a href="http://www.samsung.com/latin">www.samsung.com/latin</a>
	JAMAICA	1-800-234-7267	<a href="http://www.samsung.com/latin">www.samsung.com/latin</a>
	PANAMA	800-7267	<a href="http://www.samsung.com/latin">www.samsung.com/latin</a>
	PUERTO RICO	1-800-682-3180	<a href="http://www.samsung.com/latin">www.samsung.com/latin</a>
	REP. DOMINICA	1-800-751-2676	<a href="http://www.samsung.com/latin">www.samsung.com/latin</a>
	TRINIDAD & TOBAGO	1-800-7267-864	<a href="http://www.samsung.com/latin">www.samsung.com/latin</a>
	VENEZUELA	0-800-100-5303	<a href="http://www.samsung.com/latin">www.samsung.com/latin</a>
COLOMBIA	01-8000112112	<a href="http://www.samsung.com.co">www.samsung.com.co</a>	
Europe	BELGIUM	02 201 2418	<a href="http://www.samsung.com/be">www.samsung.com/be</a>
	CZECH REPUBLIC	844 000 844 Distributor pro Českou republiku : Samsung Zrt., česká organizační složka Vyskočilova 4, 14000 Praha 4	<a href="http://www.samsung.com/cz">www.samsung.com/cz</a>
	DENMARK	70 70 19 70	<a href="http://www.samsung.com/dk">www.samsung.com/dk</a>
	FINLAND	030-6227 515	<a href="http://www.samsung.com/fi">www.samsung.com/fi</a>
	FRANCE	3260 SAMSUNG or 08 25 08 65 65 (€ 0,15/Min)	<a href="http://www.samsung.com/fr">www.samsung.com/fr</a>
	GERMANY	01805 - 121213 (€ 0,14/Min)	<a href="http://www.samsung.de">www.samsung.de</a>
	HUNGARY	06-80-SAMSUNG (7267864)	<a href="http://www.samsung.com/hu">www.samsung.com/hu</a>
	ITALIA	800-SAMSUNG (7267864)	<a href="http://www.samsung.com/it">www.samsung.com/it</a>
	LUXEMBURG	0032 (0)2 201 24 18	<a href="http://www.samsung.lu">www.samsung.lu</a>
	NETHERLANDS	0900 20 200 88 (€ 0,10/Min)	<a href="http://www.samsung.com/nl">www.samsung.com/nl</a>
	NORWAY	815-56 480	<a href="http://www.samsung.com/no">www.samsung.com/no</a>
	POLAND	0 801 801 881	<a href="http://www.samsung.com/pl">www.samsung.com/pl</a>
	PORTUGAL	80 8 200 128	<a href="http://www.samsung.com/pt">www.samsung.com/pt</a>
	SLOVAKIA	0800-SAMSUNG (726786)	<a href="http://www.samsung.com/sk">www.samsung.com/sk</a>
	SPAIN	902 10 11 30	<a href="http://www.samsung.com/es">www.samsung.com/es</a>
	SWEDEN	0771-400 200	<a href="http://www.samsung.com/se">www.samsung.com/se</a>
	U.K	0870 SAMSUNG (7267864)	<a href="http://www.samsung.com/uk">www.samsung.com/uk</a>
	Republic of Ireland	0818 717 100	<a href="http://www.samsung.com/uk">www.samsung.com/uk</a>
	Switzerland	0800-7267864	<a href="http://www.samsung.com/ch">www.samsung.com/ch</a>
CIS	RUSSIA	8-800-200-0400	<a href="http://www.samsung.ru">www.samsung.ru</a>
	KAZAHSTAN	8-800-080-1188	<a href="http://www.samsung.kz">www.samsung.kz</a>
	UZBEKISTAN	8-800-120-0400	<a href="http://www.samsung.uz">www.samsung.uz</a>
	UKRAINE	8-800-502-0000	<a href="http://www.samsung.com/ur">www.samsung.com/ur</a>
	LITHUANIA	8-800-77777	<a href="http://www.samsung.lt">www.samsung.lt</a>
	LATVIA	800-7267	<a href="http://www.samsung.com/lv/index.htm">www.samsung.com/lv/index.htm</a>
	ESTONIA	800-7267	<a href="http://www.samsung.ee">www.samsung.ee</a>
Asia Pacific	AUSTRALIA	1300 362 603	<a href="http://www.samsung.com/au">www.samsung.com/au</a>
	CHINA	800-810-5858, 010-6475 1880	<a href="http://www.samsung.com.cn">www.samsung.com.cn</a>
	HONG KONG	3698 - 4698	<a href="http://www.samsung.com/hk">www.samsung.com/hk</a>
	INDIA	3030 8282 1800 110011	<a href="http://www.samsung.com/in">www.samsung.com/in</a>
	INDONESIA	0800-112-8888	<a href="http://www.samsung.com/id">www.samsung.com/id</a>
	JAPAN	0120-327-527	<a href="http://www.samsung.com/jp">www.samsung.com/jp</a>
	MALAYSIA	1800-88-9999	<a href="http://www.samsung.com/my">www.samsung.com/my</a>
	PHILIPPINES	1800-10-SAMSUNG (7267864)	<a href="http://www.samsung.com/ph">www.samsung.com/ph</a>
	SINGAPORE	1800-SAMSUNG (7267864)	<a href="http://www.samsung.com/sg">www.samsung.com/sg</a>
	THAILAND	1800-29-3232 02-689-3232	<a href="http://www.samsung.com/th">www.samsung.com/th</a>
	TAIWAN	0800-329-999	<a href="http://www.samsung.com/tw">www.samsung.com/tw</a>
VIETNAM	1 800 588 889	<a href="http://www.samsung.com/vn">www.samsung.com/vn</a>	
Middle East & Africa	SOUTH AFRICA	0860 7267864 (SAMSUNG)	<a href="http://www.samsung.com/za">www.samsung.com/za</a>
	U.A.E	800SAMSUNG (7267864) 8000-4726	<a href="http://www.samsung.com/mea">www.samsung.com/mea</a>





HEADQUARTERS  
105 Challenger Road, Ridgefield Park,  
N.J.07660-0511  
TEL: 1-800-SAMSUNG

SERVICE DIVISION  
400 Valley Road, Suite 201  
Mount Arlington, NJ 07856

1-800-SAMSUNG (726-7864)  
[www.samsung.com](http://www.samsung.com)